

ACRP

REPORT 51

**AIRPORT
COOPERATIVE
RESEARCH
PROGRAM**

Risk Assessment Method to Support Modification of Airfield Separation Standards

Sponsored by
the Federal
Aviation
Administration

ACRP OVERSIGHT COMMITTEE*

CHAIR

James Wilding
Metropolitan Washington Airports Authority (retired)

VICE CHAIR

Jeff Hamiel
*Minneapolis–St. Paul
Metropolitan Airports Commission*

MEMBERS

James Crites
Dallas–Fort Worth International Airport
Richard de Neufville
Massachusetts Institute of Technology
Kevin C. Dolliole
Unison Consulting
John K. Duval
Austin Commercial, LP
Kitty Freidheim
Freidheim Consulting
Steve Grossman
Jacksonville Aviation Authority
Tom Jensen
National Safe Skies Alliance
Catherine M. Lang
Federal Aviation Administration
Gina Marie Lindsey
Los Angeles World Airports
Carolyn Motz
Hagerstown Regional Airport
Richard Tucker
Huntsville International Airport

EX OFFICIO MEMBERS

Paula P. Hochstetler
Airport Consultants Council
Sabrina Johnson
U.S. Environmental Protection Agency
Richard Marchi
Airports Council International—North America
Laura McKee
Air Transport Association of America
Henry Ogrodzinski
National Association of State Aviation Officials
Melissa Sabatine
American Association of Airport Executives
Robert E. Skinner, Jr.
Transportation Research Board

SECRETARY

Christopher W. Jenks
Transportation Research Board

TRANSPORTATION RESEARCH BOARD 2011 EXECUTIVE COMMITTEE*

OFFICERS

CHAIR: Neil J. Pedersen, *Administrator, Maryland State Highway Administration, Baltimore*
VICE CHAIR: Sandra Rosenbloom, *Professor of Planning, University of Arizona, Tucson*
EXECUTIVE DIRECTOR: Robert E. Skinner, Jr., *Transportation Research Board*

MEMBERS

J. Barry Barker, *Executive Director, Transit Authority of River City, Louisville, KY*
Deborah H. Butler, *Executive Vice President, Planning, and CIO, Norfolk Southern Corporation, Norfolk, VA*
William A.V. Clark, *Professor, Department of Geography, University of California, Los Angeles*
Eugene A. Conti, Jr., *Secretary of Transportation, North Carolina DOT, Raleigh*
James M. Crites, *Executive Vice President of Operations, Dallas-Fort Worth International Airport, TX*
Paula J. Hammond, *Secretary, Washington State DOT, Olympia*
Michael W. Hancock, *Secretary, Kentucky Transportation Cabinet, Frankfort*
Adib K. Kanafani, *Cahill Professor of Civil Engineering, University of California, Berkeley*
Michael P. Lewis, *Director, Rhode Island DOT, Providence*
Susan Martinovich, *Director, Nevada DOT, Carson City*
Michael R. Morris, *Director of Transportation, North Central Texas Council of Governments, Arlington*
Tracy L. Rosser, *Vice President, Regional General Manager, Wal-Mart Stores, Inc., Mandeville, LA*
Steven T. Scalzo, *Chief Operating Officer, Marine Resources Group, Seattle, WA*
Henry G. (Gerry) Schwartz, Jr., *Chairman (retired), Jacobs/Sverdrup Civil, Inc., St. Louis, MO*
Beverly A. Scott, *General Manager and CEO, Metropolitan Atlanta Rapid Transit Authority, Atlanta, GA*
David Seltzer, *Principal, Mercator Advisors LLC, Philadelphia, PA*
Lawrence A. Selzer, *President and CEO, The Conservation Fund, Arlington, VA*
Kumares C. Sinha, *Olson Distinguished Professor of Civil Engineering, Purdue University, West Lafayette, IN*
Thomas K. Sorel, *Commissioner, Minnesota DOT, St. Paul*
Daniel Sperling, *Professor of Civil Engineering and Environmental Science and Policy; Director, Institute of Transportation Studies; and Interim Director, Energy Efficiency Center, University of California, Davis*
Kirk T. Steudle, *Director, Michigan DOT, Lansing*
Douglas W. Stotlar, *President and CEO, Con-Way, Inc., Ann Arbor, MI*
C. Michael Walton, *Ernest H. Cockrell Centennial Chair in Engineering, University of Texas, Austin*

EX OFFICIO MEMBERS

Peter H. Appel, *Administrator, Research and Innovative Technology Administration, U.S.DOT*
J. Randolph Babbitt, *Administrator, Federal Aviation Administration, U.S.DOT*
Rebecca M. Brewster, *President and COO, American Transportation Research Institute, Smyrna, GA*
Anne S. Ferro, *Administrator, Federal Motor Carrier Safety Administration, U.S.DOT*
LeRoy Gishi, *Chief, Division of Transportation, Bureau of Indian Affairs, U.S.DOT*
John T. Gray, *Senior Vice President, Policy and Economics, Association of American Railroads, Washington, DC*
John C. Horsley, *Executive Director, American Association of State Highway and Transportation Officials, Washington, DC*
David T. Matsuda, *Deputy Administrator, Maritime Administration, U.S.DOT*
Victor M. Mendez, *Administrator, Federal Highway Administration, U.S.DOT*
William W. Millar, *President, American Public Transportation Association, Washington, DC*
Tara O'Toole, *Under Secretary for Science and Technology, U.S. Department of Homeland Security, Washington, DC*
Robert J. Papp (Adm., U.S. Coast Guard), *Commandant, U.S. Coast Guard, U.S. Department of Homeland Security, Washington, DC*
Cynthia L. Quarterman, *Administrator, Pipeline and Hazardous Materials Safety Administration, U.S.DOT*
Peter M. Rogoff, *Administrator, Federal Transit Administration, U.S.DOT*
David L. Strickland, *Administrator, National Highway Traffic Safety Administration, U.S.DOT*
Joseph C. Szabo, *Administrator, Federal Railroad Administration, U.S.DOT*
Polly Trottenberg, *Assistant Secretary for Transportation Policy, U.S.DOT*
Robert L. Van Antwerp (Lt. Gen., U.S. Army), *Chief of Engineers and Commanding General, U.S. Army Corps of Engineers, Washington, DC*
Barry R. Wallerstein, *Executive Officer, South Coast Air Quality Management District, Diamond Bar, CA*

*Membership as of October 2010.

*Membership as of June 2011.

AIRPORT COOPERATIVE RESEARCH PROGRAM

ACRP REPORT 51

**Risk Assessment Method
to Support Modification
of Airfield Separation Standards**

Jim W. Hall, Jr.

APPLIED RESEARCH ASSOCIATES
Vicksburg, MS

Manuel Ayres, Jr.

APPLIED RESEARCH ASSOCIATES
Miami, FL

Hamid Shirazi

Richard Speir

Regis Carvalho

APPLIED RESEARCH ASSOCIATES
Elkridge, MD

Robert David

ROBERT E. DAVID & ASSOCIATES
Fredericksburg, VA

Yih-Ru Huang

UNIVERSITY OF OKLAHOMA
Norman, OK

Subscriber Categories
Aviation

Research sponsored by the Federal Aviation Administration

TRANSPORTATION RESEARCH BOARD

WASHINGTON, D.C.
2011
www.TRB.org

AIRPORT COOPERATIVE RESEARCH PROGRAM

Airports are vital national resources. They serve a key role in transportation of people and goods and in regional, national, and international commerce. They are where the nation's aviation system connects with other modes of transportation and where federal responsibility for managing and regulating air traffic operations intersects with the role of state and local governments that own and operate most airports. Research is necessary to solve common operating problems, to adapt appropriate new technologies from other industries, and to introduce innovations into the airport industry. The Airport Cooperative Research Program (ACRP) serves as one of the principal means by which the airport industry can develop innovative near-term solutions to meet demands placed on it.

The need for ACRP was identified in *TRB Special Report 272: Airport Research Needs: Cooperative Solutions* in 2003, based on a study sponsored by the Federal Aviation Administration (FAA). The ACRP carries out applied research on problems that are shared by airport operating agencies and are not being adequately addressed by existing federal research programs. It is modeled after the successful National Cooperative Highway Research Program and Transit Cooperative Research Program. The ACRP undertakes research and other technical activities in a variety of airport subject areas, including design, construction, maintenance, operations, safety, security, policy, planning, human resources, and administration. The ACRP provides a forum where airport operators can cooperatively address common operational problems.

The ACRP was authorized in December 2003 as part of the Vision 100-Century of Aviation Reauthorization Act. The primary participants in the ACRP are (1) an independent governing board, the ACRP Oversight Committee (AOC), appointed by the Secretary of the U.S. Department of Transportation with representation from airport operating agencies, other stakeholders, and relevant industry organizations such as the Airports Council International-North America (ACI-NA), the American Association of Airport Executives (AAAE), the National Association of State Aviation Officials (NASAO), and the Air Transport Association (ATA) as vital links to the airport community; (2) the TRB as program manager and secretariat for the governing board; and (3) the FAA as program sponsor. In October 2005, the FAA executed a contract with the National Academies formally initiating the program.

The ACRP benefits from the cooperation and participation of airport professionals, air carriers, shippers, state and local government officials, equipment and service suppliers, other airport users, and research organizations. Each of these participants has different interests and responsibilities, and each is an integral part of this cooperative research effort.

Research problem statements for the ACRP are solicited periodically but may be submitted to the TRB by anyone at any time. It is the responsibility of the AOC to formulate the research program by identifying the highest priority projects and defining funding levels and expected products.

Once selected, each ACRP project is assigned to an expert panel, appointed by the TRB. Panels include experienced practitioners and research specialists; heavy emphasis is placed on including airport professionals, the intended users of the research products. The panels prepare project statements (requests for proposals), select contractors, and provide technical guidance and counsel throughout the life of the project. The process for developing research problem statements and selecting research agencies has been used by TRB in managing cooperative research programs since 1962. As in other TRB activities, ACRP project panels serve voluntarily without compensation.

Primary emphasis is placed on disseminating ACRP results to the intended end-users of the research: airport operating agencies, service providers, and suppliers. The ACRP produces a series of research reports for use by airport operators, local agencies, the FAA, and other interested parties, and industry associations may arrange for workshops, training aids, field visits, and other activities to ensure that results are implemented by airport-industry practitioners.

ACRP REPORT 51

Project 04-09
ISSN 1935-9802
ISBN 978-0-309-21332-5
Library of Congress Control Number 2011931183

© 2011 National Academy of Sciences. All rights reserved.

COPYRIGHT INFORMATION

Authors herein are responsible for the authenticity of their materials and for obtaining written permissions from publishers or persons who own the copyright to any previously published or copyrighted material used herein.

Cooperative Research Programs (CRP) grants permission to reproduce material in this publication for classroom and not-for-profit purposes. Permission is given with the understanding that none of the material will be used to imply TRB or FAA endorsement of a particular product, method, or practice. It is expected that those reproducing the material in this document for educational and not-for-profit uses will give appropriate acknowledgment of the source of any reprinted or reproduced material. For other uses of the material, request permission from CRP.

NOTICE

The project that is the subject of this report was a part of the Airport Cooperative Research Program, conducted by the Transportation Research Board with the approval of the Governing Board of the National Research Council.

The members of the technical panel selected to monitor this project and to review this report were chosen for their special competencies and with regard for appropriate balance. The report was reviewed by the technical panel and accepted for publication according to procedures established and overseen by the Transportation Research Board and approved by the Governing Board of the National Research Council.

The opinions and conclusions expressed or implied in this report are those of the researchers who performed the research and are not necessarily those of the Transportation Research Board, the National Research Council, or the program sponsors.

The Transportation Research Board of the National Academies, the National Research Council, and the sponsors of the Airport Cooperative Research Program do not endorse products or manufacturers. Trade or manufacturers' names appear herein solely because they are considered essential to the object of the report.

Published reports of the

AIRPORT COOPERATIVE RESEARCH PROGRAM

are available from:

Transportation Research Board
Business Office
500 Fifth Street, NW
Washington, DC 20001

and can be ordered through the Internet at
<http://www.national-academies.org/trb/bookstore>

Printed in the United States of America

THE NATIONAL ACADEMIES

Advisers to the Nation on Science, Engineering, and Medicine

The **National Academy of Sciences** is a private, nonprofit, self-perpetuating society of distinguished scholars engaged in scientific and engineering research, dedicated to the furtherance of science and technology and to their use for the general welfare. On the authority of the charter granted to it by the Congress in 1863, the Academy has a mandate that requires it to advise the federal government on scientific and technical matters. Dr. Ralph J. Cicerone is president of the National Academy of Sciences.

The **National Academy of Engineering** was established in 1964, under the charter of the National Academy of Sciences, as a parallel organization of outstanding engineers. It is autonomous in its administration and in the selection of its members, sharing with the National Academy of Sciences the responsibility for advising the federal government. The National Academy of Engineering also sponsors engineering programs aimed at meeting national needs, encourages education and research, and recognizes the superior achievements of engineers. Dr. Charles M. Vest is president of the National Academy of Engineering.

The **Institute of Medicine** was established in 1970 by the National Academy of Sciences to secure the services of eminent members of appropriate professions in the examination of policy matters pertaining to the health of the public. The Institute acts under the responsibility given to the National Academy of Sciences by its congressional charter to be an adviser to the federal government and, on its own initiative, to identify issues of medical care, research, and education. Dr. Harvey V. Fineberg is president of the Institute of Medicine.

The **National Research Council** was organized by the National Academy of Sciences in 1916 to associate the broad community of science and technology with the Academy's purposes of furthering knowledge and advising the federal government. Functioning in accordance with general policies determined by the Academy, the Council has become the principal operating agency of both the National Academy of Sciences and the National Academy of Engineering in providing services to the government, the public, and the scientific and engineering communities. The Council is administered jointly by both Academies and the Institute of Medicine. Dr. Ralph J. Cicerone and Dr. Charles M. Vest are chair and vice chair, respectively, of the National Research Council.

The **Transportation Research Board** is one of six major divisions of the National Research Council. The mission of the Transportation Research Board is to provide leadership in transportation innovation and progress through research and information exchange, conducted within a setting that is objective, interdisciplinary, and multimodal. The Board's varied activities annually engage about 7,000 engineers, scientists, and other transportation researchers and practitioners from the public and private sectors and academia, all of whom contribute their expertise in the public interest. The program is supported by state transportation departments, federal agencies including the component administrations of the U.S. Department of Transportation, and other organizations and individuals interested in the development of transportation. www.TRB.org

www.national-academies.org

COOPERATIVE RESEARCH PROGRAMS

CRP STAFF FOR ACRP REPORT 51

Christopher W. Jenks, *Director, Cooperative Research Programs*
Crawford F. Jencks, *Deputy Director, Cooperative Research Programs*
Michael R. Salamone, *ACRP Manager*
Marci A. Greenberger, *Senior Program Officer*
Tiana M. Barnes, *Senior Program Assistant*
Eileen P. Delaney, *Director of Publications*
Ellen Chafee, *Editor*

ACRP PROJECT 04-09 PANEL

Field of Safety

Laurie Cullen, *HNTB Corporation, Boston, MA* (Chair)
Gary Cathey, *California DOT, Sacramento, CA*
Chad A. Gunderson, *TKDA, St. Paul, MN*
Paul Herrera, *Los Angeles World Airports, Los Angeles, CA*
Scott McMahon, *Morristown Municipal Airport, Morristown, NJ*
Jorge E. Panteli, *McFarland-Johnson, Inc., Concord, NH*
John Dermody, *FAA Liaison*
Chris Oswald, *Airports Council International–North America Liaison*
Christine Gerencher, *TRB Liaison*

AUTHOR ACKNOWLEDGMENTS

The research reported herein was performed under ACRP Project 04-09 by Applied Research Associates, Inc. (ARA), Robert E. David & Associates, LCC (RED), Oklahoma University (OU), and Mr. Arun Rao. ARA was the contractor for this study, and RED, OU, and Mr. Rao served as subconsultants.

Dr. Jim Hall, P.E., Principal Engineer at ARA, was the Principal Investigator; Dr. Manuel Ayres, Principal Engineer at ARA, was the Project Manager; and Mr. Richard Speir, ARA Mid-Atlantic Division Manager served as Co-Principal Investigator. The other authors of this report are Mr. Hamid Shirazi (ARA), Mr. Robert David (RED), Dr. Yih-Ru Huang (OU), Mr. Regis Carvalho (ARA), Dr. Samuel Cardoso (ARA), and Ms. Edith Arambula (ARA). The work was done under the general supervision of Dr. Manuel Ayres.

FOREWORD

By **Marci A. Greenberger**

Staff Officer

Transportation Research Board

ACRP Report 51: Risk Assessment Method to Support Modification of Airfield Separation Standards provides a methodology that airports can use to support their request for modification of standards. It is intended to be used in those circumstances where the design criteria for separations between taxiways/taxilanes and (1) other taxiways/taxilanes and (2) fixed or movable objects as well as separations between taxiways and runways cannot be met. This risk-based methodology will be useful to airport staff and their consultants as they assess the risks associated with non-standard separations at existing constrained airports where the standards can't be practicably met.

To ensure safe operations, FAA-specified airfield design criteria include standards between runways and taxiways and other movement areas and fixed and moveable objects. As many airports were designed long before current design standards and as airplane design and operational realities have changed, so have the impacts that the separation standards can have on existing airfield operations. To account for these realities, the FAA does accept requests from airports for modification of standards.

As risk assessments become more and more a part of any decision-making criteria in many if not all aspects of airport operations and management, it is timely then that this risk-based methodology for assessing and justifying requests to modify separation standards has been developed. Applied Research Associates, Inc. (ARA) was retained under ACRP Project 04-09 to develop a method for assessing the risks associated with non-standard separations. The result of their efforts is *ACRP Report 51: Risk Assessment Method to Support Modification of Airfield Separation Standards*. The methodology was developed in part by analyzing data associated with aircraft veering from runway and taxiway centerlines and determining the probability of incidents occurring. ARA validated their methodology by examining actual modification of standards cases that were approved by the FAA.

Three of the report's appendices will be particularly helpful to the user in understanding the methodology. Appendix A: Risk Assessment Methodology presents a methodology for five different types of circumstances: taxiway/taxilane to taxiway, taxiway to object, taxilane to taxilane, taxilane to an object, and runway to taxiway/taxilane or object. Appendix F: Aircraft Database Summary presents a summary of aircraft characteristics by model, and Appendix H: Analysis of MOS Cases summarizes information collected in the modification of standards survey and presents results of application of the methodology described in Appendix A to each modification of standards case. Other report appendices provide detail and information on the development of the methodology and are provided on the TRB website at <http://www.trb.org/Main/Blurbs/165180.aspx>. Posted at the same URL on the TRB website is a PowerPoint presentation that may be useful for introducing and explaining the methodology to stakeholders.

C O N T E N T S

1	Summary
2	Chapter 1 Background
2	Introduction
2	Project Goals
2	Major Challenges Associated with Airfield Separations
3	FAA Modification of Standards
4	Chapter 2 Airfield Separation Rationale
4	FAA Rationale
8	ICAO Rationale
12	Chapter 3 Data for Modeling Aircraft Deviations
12	Airfield Lateral Deviation Studies
12	Veer-Off Accidents and Incidents
13	Aircraft Veer-Off Database Organization
14	Normal Operations Data (NOD)
15	Aircraft Data
16	Chapter 4 Methodology Approach
16	Taxiway and Taxilane Deviation Modeling
21	Runway Deviation Modeling
28	Chapter 5 Validating the Methodology
28	MOS Case Studies
28	MOS Survey
28	Methodology Applied to MOS Cases
31	Chapter 6 Conclusions and Recommendations
31	Major Achievements
32	Limitations
32	Recommendations for Future Work
34	Glossary of Acronyms
36	Definitions
37	References
A-1	Appendix A Risk Assessment Methodology
B-1	Appendix B Collision Risk Model
C-1	Appendix C Key Studies on Aircraft Deviation
D-1	Appendix D List of Veer-Off Accidents and Incidents
E-1	Appendix E Sample of Normal Operations Data

- F-1 **Appendix F** Aircraft Database Summary
- G-1 **Appendix G** Summary of FAA/Boeing Taxiway Deviation Studies
- H-1 **Appendix H** Analysis of MOS Cases

Note: Many of the photographs, figures, and tables in this report have been converted from color to grayscale for printing. The electronic version of the report (posted on the Web at www.trb.org) retains the color versions.

S U M M A R Y

Risk Assessment Method to Support Modification of Airfield Separation Standards

The Federal Aviation Administration (FAA) sets standards for the planning and design of airports to provide safe aircraft operations. These design standards include separation distances between various airfield components such as runways and taxiways, taxiways and taxiways, and taxiways and objects.

Many U.S. airports were built according to older FAA design standards and were planned to accommodate smaller aircraft. With the rapid growth of aviation demand since World War II, many airports are facing the need to increase capacity and to accommodate larger and faster aircraft. However, some airports are finding it a challenge to modify existing airfield separations to meet current standards for larger aircraft because they are constrained by physical barriers, environmentally sensitive areas, and encroaching development.

When it is not feasible to meet existing separations, airports may submit to the FAA a request for modification of standards (MOS) to demonstrate that there are unique local conditions that restrict extending the airfield and to show that the modification will “provide an acceptable level of safety, economy, durability, and workmanship” (FAA, 1989). In requests for an MOS to a separation standard, the main concern is usually the safety of operations. As the FAA and the aviation industry transition to a safety management approach to improve safety, it is important that risks associated with changes be assessed.

Authorization for MOS may be granted if the MOS fulfills the criteria described in FAA’s Advisory Circular (AC) 150/5300-13, Airport Design, which specifically addresses taxiway and taxilane separations (FAA, 1989). The criteria do not provide an assessment of risk that may be used for specific airfield scenarios, including the separation between runways and other airfield components (taxiways, taxilanes, and objects). Adherence to the FAA requirements can affect airport efficiency and capacity and, potentially, prevent certain aircraft from using an airfield.

The objective of this research effort was to develop a simple and practical methodology for assessing the risk of aircraft collisions associated with non-standard airfield separations. The tool developed is intended to support MOS requests for non-standard separations.

A practical, risk-based methodology to evaluate airfield separations was developed. The methodology is based on the probability of lateral and vertical deviations from the intended path during landing, takeoff, and taxiing operations. A series of risk plots based on center-line or wingtip separations is provided for each Aircraft Design Group (ADG), and step-by-step procedures are described for each type of separation involved in the analysis, such as runway and taxiway, and taxiway and taxiway.

The methodology was validated using actual MOS cases approved by the FAA that covered a spectrum of scenarios, airports, and FAA regions. Relevant information was gathered for each case to characterize the non-standard situation and was analyzed using the methodology developed in this study. Risk criteria were suggested based on the risk matrix used by the FAA in safety management systems, on the evidence of accident and incident rates, and the consequences gathered in this research effort.

CHAPTER 1

Background

Introduction

The modernization and complexity of the National Airspace System (NAS) have increased considerably in the last four decades, and its components require continuous improvements to increase capacity and safety. Airports are one of the main components of this complex and dynamic system.

To meet higher demands for flights, airlines are operating larger aircraft with greater seating capacity. However, the airfield configurations at many airports were established years ago, and many existing airports were designed and constructed in the 1960s and 1970s to accommodate the smaller aircraft in use at that time. As a consequence, some of these airports have airfield separations that are not compatible with current Federal Aviation Administration (FAA) design requirements and recommendations. Moreover, existing airports need to increase their capacity to meet demand. Many of these airports are constrained by urban development and physical and environmental restrictions, or they do not have the necessary real estate to accommodate the applicable separation standards.

With this potential traffic growth, many airports will need to bring larger aircraft and use instrumented runways to increase their capacity; however, existing separations may not be appropriate for larger aircraft or for upgraded approach categories.

When existing separations do not meet FAA standards, a request for modification of standards (MOS) may be required, and authorization for the operation may be granted if the MOS fulfills the criteria described in FAA's Advisory Circular (AC) 150/5300-13, Airport Design (FAA, 1989). In the context of this study, MOS means any change to FAA dimensional standards, other than those for runway safety areas (RSAs), applicable to an airport design or construction project (new, reconstruction, expansion, or upgrade).

So far, requests dealing with airfield separations have been analyzed according to non-risk-based methodologies, and the only available guidance is described in AC 150/5300-13 (FAA, 1989). This process can affect airport efficiency and capacity and, potentially, prevent certain aircraft from using an airfield.

On the other hand, some of the factors that lead to aircraft accidents/incidents are considered under subjective criteria. This research addresses a more consistent risk-based decision-making process to analyze the separation standards at those constrained airports.

Project Goals

The main objective of this research was to develop a methodology for assessing the risk of aircraft collisions associated with non-standard airfield separations. The methodology is intended to provide a quantitative basis to support MOS requests by airport operators for airfield separations that do not meet FAA standards. This study is not aimed at modifying existing standards but rather at allowing an airport operator to assess the level of safety when those standards cannot be met. The methodology was developed to be simple and practical, allowing airport operators to estimate whether the level of risk is acceptable and to compare it to the level of risk achieved when the standard separations are met.

Major Challenges Associated with Airfield Separations

In the coming years, it is expected that air transportation will experience greater growth than has been observed during the 2008 to 2011 recession period. Anticipating the higher demand for flights, airlines are operating larger aircraft with greater seating capacity. However, it is sometimes impracticable to meet the separation standards for larger aircraft due to a number of physical, social, economical, and environmental limitations.

There is no acceptable method available to estimate the level of protection provided by existing airport layouts when evaluating the operation of large aircraft in terms of the probability of collision with another aircraft, vehicle, or object. Current separation standards have provided an excellent level of safety, as evidenced by the small number of accidents associated with

lateral deviations of aircraft. However, when standards cannot be met, there is no process by which to evaluate the level of risk of the smaller airfield separations.

Many aircraft collisions occur during taxiing operations. Over 20 percent of Part 121 accidents in 2005 were characterized as on-ground collisions with objects during taxi or standing (NTSB, 2009). These are collisions between two aircraft, between an aircraft and ground equipment, or between an aircraft and a stationary structure. Some of these accidents may be associated with airfield separations, and it is necessary to evaluate how these separations and lateral aircraft deviations interact to provide an assessment of the risk of collision.

Over 34 percent of fatal accidents with worldwide commercial jets occur on the ground (Boeing, 2009). Runway veer-offs and overruns represent 24 percent of all incidents and accidents in air transport operations (IFALPA, 2008). These types of events happen at an approximate rate of one per week, emphasizing the challenge that airport operators face, particularly when considering substandard airfield separation distances.

The Australian Transport Safety Bureau (ATSB) analyzed 141 accidents with 550 fatalities for commercial aircraft worldwide from 1998 to 2007. All fatal accidents were catastrophic runway excursions, and 120 of these occurred during landings (ATSB, 2009).

Airfield separations and runway and taxiway safety areas have been established and regulated to help reduce the risk of collisions and to mitigate the consequences of runway and taxiway excursions. Airfield separations are determined on the basis of the location, aircraft wingspan, random lateral and vertical deviations, and a separation margin of safety to account for extreme deviations. Over the years, aircraft wingspans have been increasing gradually, and the FAA has developed new separation standards to accommodate these larger aircraft.

The introduction of new large aircraft (NLA) is still in process and will continue bringing challenges to the aviation industry. NLA will have a significant impact predominantly on existing airports, particularly large hubs, due to the aircraft passenger capacity, weight, wingspan, length, tail height, and wheelbase. Some of the current airport separations between runways versus runways, taxiways, taxilanes, moveable and fixed objects, and taxiways versus taxiways, taxilanes, moveable and fixed objects, etc., may not be adequate to accommodate the introduction of NLA. Most airports with separations inadequate to accommodate NLA do not have enough space for construction of new facilities or for relocation of existing facilities to comply with current FAA standards.

It is important to emphasize that it is not only NLAs or existing aircraft like Lockheed C5 and Antonov AN124 that pose challenges to existing airports; recent and new aircraft, such as the Airbus A340-600 and B777-300 ER, require changes in some aspects of airport infrastructure due to their long fuselage length and associated long wheelbase.

FAA Modification of Standards

The FAA established the Airport Reference Code (ARC) system to aid in the geometric design of runways, taxiways, and other airport facilities. The system and the airfield separations associated with each code are described in AC 150/5300-13 (FAA, 1989). The ARC is based on aircraft dimensions and approach speeds to define several physical characteristics of airfields, including airfield separations. Standard distances were established for each aircraft category; although in certain cases it is possible to request a modification of standards.

According to AC 150/5300-13 (FAA, 1989):

Modification to standards means any change to FAA design standards other than dimensional standards for runway safety areas. Unique local conditions may require modification to airport design standards for a specific airport. A modification to an airport design standard related to new construction, reconstruction, expansion, or upgrade on an airport which received Federal aid requires FAA approval. The request for modification should show that the modification will provide an acceptable level of safety, economy, durability, and workmanship. (CHG 10, Chapter 1, p. 5)

A survey conducted by the FAA in 2008 identified 142 airports that can accommodate Cat II and Cat III approaches. Of these 142 airports, 63 airports have less than a 500-ft separation between the runway and parallel taxiway, and three have less than a 400-ft separation, measured within the first 3,000 ft of the runway.

What is the risk if larger aircraft are allowed to operate at these airports with non-standard separations? Currently, there are no risk-based methodologies for assessing such risks, and each situation is treated as a unique case. The FAA may allow operation at airports that do not comply with minimum separation distances by evaluating an MOS submitted by the airport operator. The objective is to keep the airport/aircraft operations at a level of safety equivalent to that achieved by standard separations.

The FAA uses a computer program that considers the relationship between airplane physical characteristics and the design of airport elements to show that an MOS provides an acceptable level of safety for the specified conditions, including the type of aircraft (FAA, 1989).

AC 150/5300-13 also states that values obtained from the specific equations presented in the next chapter may be used to demonstrate that an MOS will provide an acceptable level of safety (FAA, 1989). The criteria are based on engineering judgment and can only be used to compare taxiway and taxilane separations. However, in the context of this study, it was necessary to address separations between runways and taxiways or taxilanes. There is no procedure in the FAA guidance material to evaluate runway separations for the risk of collision between an aircraft landing or taking off and a taxiing aircraft or an object.

CHAPTER 2

Airfield Separation Rationale

A preliminary task in the study was the identification of approaches that could be used as a framework for the risk-assessment methodology. The first step was the gathering of information on two basic rationales—that used by the FAA and that used by the International Civil Aviation Organization (ICAO)—to establish their airfield separation standards.¹ The bases for the development of both rationales were the random deviations of aircraft during operations. Such deviations are greater for runways and less for taxiways and taxilanes. In addition, some incidents may lead to very large deviations (e.g., runway excursions), and safety areas must be planned to mitigate the risk of these large deviations.

FAA Rationale

Most of the FAA documents reviewed for this study present the separation standards and sometimes identify design considerations, but they rarely provide detailed information on the design rationale. For this reason, two engineers were interviewed. They worked in the FAA airport organization that was responsible for developing design standards, including the separation standards. Also, an attempt was made to place several of the documents in the context of the historical time when they were issued.

In 1940, the Civil Aeronautics Authority issued a document entitled *Airport Design Information* (1940). The manual was “prepared for the instruction and guidance of Airport Section Engineers in their field consultation activities” (Hathi Trust Digital Library). It provided standards for four airport classes that were based on runway lengths required by aircraft expected to use the facility. The Civil Aeronautics Administration (CAA) published an updated version of this manual in 1941. In April

¹ FAA and ICAO may use different terminology for their standards and recommended practices. Throughout the text, the original terms for each agency were kept. For example, the FAA “runway safety area” function is equivalent to that of ICAO’s “graded area of the runway strip” plus its “runway end safety area.”

1944, the CAA published the first of four manuals titled *Airport Design*. This manual had standards for five classes of airports, with the classes based on runway lengths required by aircraft expected to use the facility.²

It is important to remember that these manuals were developed just prior to and during World War II. At that time, the United States had a massive war mobilization effort underway, and it is unknown if the manuals were the output of any intensive research and development effort. In all likelihood, the standards were based on the best engineering judgment of the era.

In January 1949, the CAA published the second manual titled *Airport Design*, and it provided for eight different airport classes. These classes were based on the type of service rather than the expected type of aircraft.

In relation to the historical context of this document, there are two points worthy of note:

- The standards contained in the document represent the knowledge gained from aircraft operations during World War II.
- In 1946, the Federal Aid Airport Program (FAAP) was enacted to provide federal funds to airport sponsors for capital development at their airports, and the program required that such development be done in accordance with standards issued by the CAA.

The importance of the FAAP cannot be overemphasized. This carrot and stick approach was successful in achieving uniformity of design within the various airport classes; however, there were so many classes that it was easy to incorrectly predict an airport’s ultimate role in the national airport system.

² The information on these manuals is taken from a paper prepared by Robert David in 1973 (David, 1973). At that time, the documents were obtained from the FAA library, but they are no longer available.

Table 1. Minimum clearance standards of airports (ft) (FAA, 1959).

Type of Service	Runway Centerline to Taxiway Centerline	Centerline of Parallel Runways for Contact Operations	Centerline of Parallel Taxiways	Taxiway Centerline to Aircraft Parking Areas	Taxiway Centerline to Obstacle
Secondary	150	300	125	100	75
Local	250	500	200	175	100
Trunk	350	500	275	240	150
Continental	400	700	300	260	175
Intercontinental	450	700	325	280	200

In August 1959, the FAA issued Airport Engineering Data Sheet Item 24 as a revision to the table that appeared in the 1949 publication (see Table 1).

This data sheet reduced the number of airport classes from eight to five. The data sheet stated, “In order to assure maximum safety and the economical and efficient use of the airport site, careful consideration must be given to the clearance and separation between the various aircraft operating areas” (FAA, 1959, p. 1). It states that the distances established are recommendations and further states “increases to these distances may be desirable in some cases, necessary in others” (FAA, 1959, p. 1). It appears that although some classes were consolidated and renamed, only minor changes were made to the actual distances. No specific information is provided as to how these separation standards were defined.

This document was issued 2 months before the “jet” age in U.S. commercial aviation began. In October 1959, nonstop transatlantic flights with Boeing 707s were initiated between New York’s Idlewild Airport (now known as John F. Kennedy International Airport) and Europe.

In 1961, the FAA published the third document titled *Airport Design* (Federal Aviation Agency, 1961). The revised standards (see Table 2) were no longer based upon the type of service, but rather on the runway length.

In the early 1960s, the FAA initiated the Advisory Circular publication series. Although the information in these publica-

tions was advisory, the airport standards contained in them became mandatory when federal aid was used for airport development. As documents were updated to conform to the new publication system, there was a tendency to develop Advisory Circulars containing design information for a specific type of airport. For example, AC 150/5300-1, VFR Airports, applied to airports that were intended to have operations by general aviation aircraft during visual meteorological conditions (FAA, 1963). AC 150/5300-4A, Utility Airports, was issued to provide guidance and standards for airports that intended to serve aircraft weighing 12,500 lb or less (FAA, 1968).

During the late 1960s and through the 1970s, there were several Advisory Circulars published on specific aspects of airport design for airports intended to serve air carriers. Subjects of these Advisory Circulars included such things as runway geometry, taxiways, surface gradient and line-of-sight, and jet blast.

During this period, there were no funds allocated for the research and development of design standards. The runway/runway and runway/taxiway separation standards contained in these publications were based on the experience gained during the post-World War II period, including experience with the precision of navigational aids such as instrument landing systems (ILSs), the ability of pilots to stay on centerline, and air traffic control considerations. In the 1960s, the FAA’s Flight Standards organization and the ICAO Obstacle Clearance Panel (OCP) developed the Collision Risk Model (CRM)³ for ILS operations. The CRM was based on actual observation of 2,500 aircraft on an ILS precision approach to a runway. Four observations were made for each aircraft’s approach. This model was used to define the area that needed to be protected on an airport when an aircraft was making an ILS approach. The runway/taxiway separation also took into account the possibility of an aircraft on landing rollout or takeoff roll veering off the runway. Additional information on the CRM is provided in [Appendix B](#).

Table 2. Airport design and clearance recommendations (ft) (Federal Aviation Agency, 1961).

Runway Length	Runway Centerline to Taxiway Centerline	Centerline of Parallel Taxiways	Taxiway Centerline to Aircraft Parking Areas	Taxiway Centerline to Obstacle
1,600–3,200	150	100	100	75
3,201–4,200	250	200	175	100
4,201–6,000	400	300	250	200
6,001–7,500	400	300	250	200
7,501–10,500	400	300	250	200

³ FAA developed the CRM (ICAO, 1980) approach with the University of Oklahoma and input from other countries represented on ICAO’s OCP.

The taxiway/taxiway separations were based on taking the most critical aircraft that would be using the taxiways (generally, the aircraft with the largest wingspan) and placing its main gear on the edge of the usable taxiway. The separation between the taxiway centerlines then could be calculated by adding half the width of each taxiway to twice the length of the wingspan that extended beyond the taxiway plus a safety factor. Likewise, the taxiway/object separations were based on taking the most critical aircraft that would be using the taxiways and placing its main gear on the edge of the usable taxiway. The separation between the taxiway centerline and the object could then be calculated by adding half the width of the taxiway to the length of the wingspan that extended beyond the taxiway plus a safety factor.

In the 1980s, in response to feedback from the aviation community, the FAA undertook an effort to consolidate the numerous design Advisory Circulars. In 1983, AC 150/5300-12, Airport Design Standards—Transport Airports, was published (FAA, 1983). This consolidated many of the design standards for transport aircraft into one document. In 1989, the FAA published AC 150/5300-13, Airport Design (the fourth document with this title), which consolidated the design standards for all airports except heliports and sea plane bases into one document (FAA, 1989). This publication grouped standards according to the ARC, consisting of a letter and a Roman numeral. The letter indicates the aircraft approach category and relates to the FAA Flight Standards approach speed group of the design aircraft (as used in terminal instrument procedures [TERP]). Generally, runway standards are related to the approach speed. The Roman numeral relates to the airport design group and the aircraft wingspan of the design aircraft. It is possible to have the approach category based on one design aircraft and the aircraft design group based on a different design aircraft.

Appendix 9 of AC 150/5300-13 provides the design rationale for separations associated with taxiways and taxilanes, except for those between a runway and its parallel taxiway (FAA, 1989). A number of parameters are contained in this appendix. To maintain airport operational capacity, the taxiway system should be designed so that aircraft can maintain an average speed of 20 mph. The parameters affecting taxiway separations for other than parallel taxiways are wingspan and wingtip clearance, with the need for wingtip clearance being driven by the fact that pilots of most modern jets cannot see their wingtips from the cockpit. Appendix 9 then provides the following information on separations:

- Taxiway to taxiway centerline (see Figure 1): Separation is calculated based on 1.2 times the wingspan of the most demanding aircraft plus 10 ft (wingtip clearance).

$$S_{\text{TWY-TWY}} = 1.2 * \text{WS} + 10 \text{ ft}$$

where

$S_{\text{TWY-TWY}}$ is taxiway to taxiway centerline separation and WS is wingspan of the most demanding aircraft.

- Taxiway centerline to object (see Figure 2): Separation is calculated based on 0.7 times the wingspan of the most demanding airplane plus 10 ft (wingtip clearance).

$$S_{\text{TWY-OBJ}} = 0.7 * \text{WS} + 10 \text{ ft}$$

where

$S_{\text{TWY-OBJ}}$ is taxiway centerline to object separation.

- Taxiway object free area (OFA): Width is equal to twice the taxiway centerline to object separation.

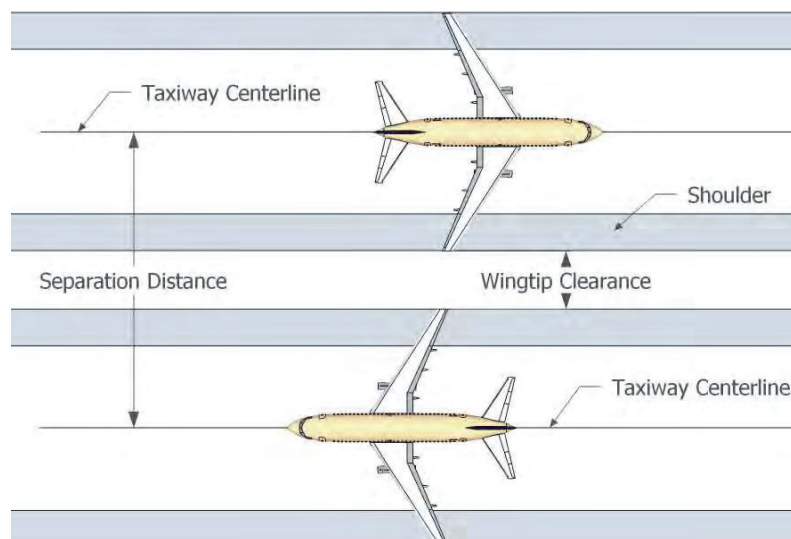

Figure 1. Wingtip clearance, parallel taxiways.

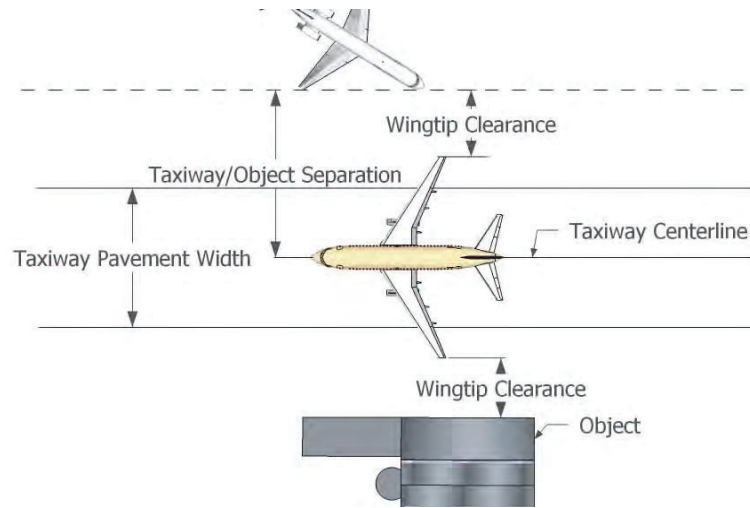

Figure 2. Wingtip clearance from taxiway.

$$TWY-OFA = 2 * S_{TO}$$

where

TWY-OFA is taxiway object free area width and S_{TO} is taxiway centerline to object separation.

- Taxilane centerline to object (see Figure 3): Separation is calculated based on 0.6 times the wingspan of the most demanding airplane plus 10 ft (wingtip clearance). Reduced clearances are acceptable because taxi speed is very slow outside the movement area, taxiing is precise, and special operator guidance techniques and devices normally are present.

$$S_{TXL-OBJ} = 0.6 * WS + 10$$

- Taxilane OFA (see Figure 4): Width is equal to twice the taxilane centerline to object separation for a single lane width and 2.3 times the wingspan of the most demanding airplane plus 30 ft for a dual lane.

$$TXL-OFA = 2 * S_{TXL-OBJ} \text{ (single lane)}$$

$$TXL-OFA = 2.3 * WS + 30 \text{ ft (dual lane)}$$

Appendix 9 of AC 150/5300-13 does not indicate how the safety factors or the wingtip clearances were determined (FAA, 1989). Interviews indicated that these factors were based on engineering judgment.

As far back as the 1970s, and probably even before then, there were differences in airport design standards and the criteria used to establish instrument approaches. These differences primarily affected the standards associated with runway approaches and separations. Several attempts were made over the years to resolve these differences. This issue became critical in the early 2000s, when an analysis performed using the CRM indicated that aircraft located on a parallel taxiway 400 ft from the runway centerline posed a safety risk to aircraft on an instrument approach to that runway when those aircraft executed a missed approach.

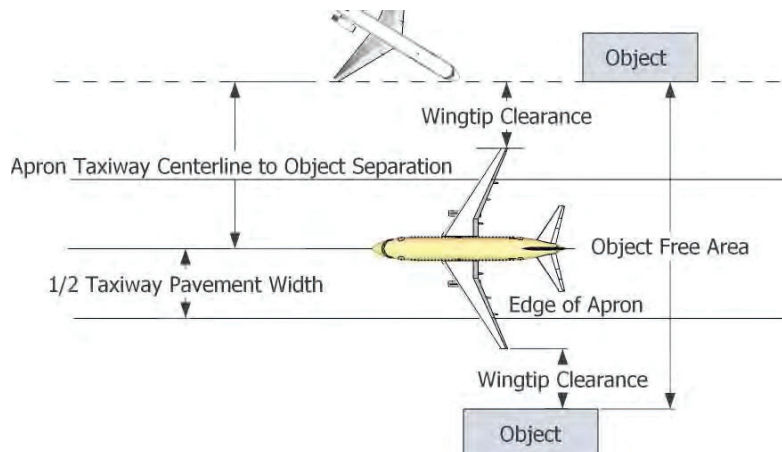

Figure 3. Wingtip clearance for taxilanes.

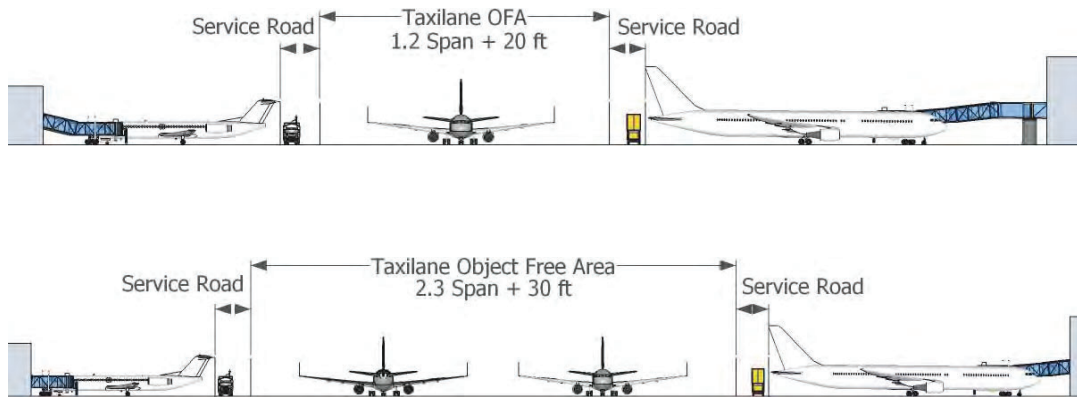

Figure 4. Wingtip clearance for taxilanes.

The issue was given to a multidisciplinary group called the Airport Obstructions Standards Committee (AOSC) to resolve. After much deliberation, this group grandfathered runways and taxiways meeting existing separation standards into the airport design standards and determined further analysis was necessary. In the interim, separation standards for construction of new runways or taxiways were increased to 500 ft for Cat II/III operations involving Group V aircraft and for Cat I approaches involving Group VI aircraft. For Group VI aircraft making a Cat II/III approach, a separation of 550 ft would be required between new runways and taxiways. The AOSC work is documented in *AOSC Decision Document #04* (AOSC, 2005).

ICAO Rationale

To harmonize the development of aviation (including airports) globally, the ICAO was established toward the end of World War II with the signing of the Convention on International Civil Aviation (also known as the Chicago Convention) on December 7, 1944. Since then, ICAO has developed and updated international specifications on all aspects of aviation. In Annex 14 to the Chicago Convention, first published in 1949, the ICAO promulgated specifications on airport design and operations (ICAO, 1949).

ICAO has kept pace with technological developments in the aircraft industry and kept Annex 14 current to provide to its Contracting States (or Member Nations) the minimum safety specifications for designing new airports and upgrading existing ones to handle succeeding generations of newer, larger, and heavier aircraft.

Many of the current standards and recommended practices (SARPs) contained in Chapter 3 of Annex 14 were defined by the Aerodrome Reference Code Panel (ARCP) in 1981 (ICAO, 1981). As part of the process to define a new reference code for airports, ARCP also undertook a fundamental review of SARPs based on a more rational approach.

In 1990, Annex 14 was separated into two volumes (ICAO, 1990). Volume I now contains international specifications on

aerodrome design and operations only, and Volume II deals with the design of heliports.

Statistics have shown that approach and landing is the most critical phase of a flight because the aircraft must follow a precise and stable approach path despite the challenging circumstances that characterize this flight phase—aircraft engine power is at its minimum, weather conditions on the ground may pose difficulties for landing, and habitation and land developments surrounding airports can be significantly impacted by deviations from the approach path.

Moreover, aircraft may sometimes touchdown before the runway arrival end or reject the takeoff and depart the runway if something goes wrong. These are the main reasons runways have a safety area. The FAA refers to this area as an RSA, whereas the ICAO defines an area with an equivalent function, consisting of the runway strip plus the runway end safety area (RESA). The objective of this area is to reduce the risk of damage to aircraft running off a runway and protect aircraft flying over a runway during takeoff or landing operations. The safety area applies not only to the airspace on or around an airport but also to the ground itself.

Runway Strip Width

ARCP's basis for the specifications of the graded portion of the strip is the acceptable risk of occurrence of aircraft veer-offs. From the information available, there seems to be no defined basis for the development of the specification of the full strip width for the protection of over-flying aircraft using the CRM. ARCP identified the following factors in the definition of the strip width:

- Aircraft approach speed
- Wingspan
- Aircraft mass
- Type of approach (visual or instrument)

Statistical data on aircraft veer-off events presented at the 8th Air Navigation Conference in 1974 were the basis for the

analysis. The frequency of veer-offs exceeding a given distance from the runway centerline were determined according to the type of operation and class of aircraft.

To maintain a safety area around the runway, a runway strip width of 984 ft (300 m) is specified for instrument runways, and a runway strip of 492 ft (150 m) is specified for smaller, non-instrument runways. The strip is symmetrically located on either side of the runway centerline. The central portion is required to be graded to certain specified slopes so that it is less likely that an aircraft will suffer substantial damage during runway veer-offs. These requirements are used to establish a safety area around the runway in which only those objects that must be located there are permitted, subject to the applicable frangibility criteria being met.

Airfield Separations

Every aircraft landing or taking off on a runway must proceed along a system of taxiways. During these movements, aircraft should be protected by wide, obstacle-free areas; thus, even the circulation areas (taxiways and aprons) must be located at suitable distances apart and at a specified distance from the runway.

The early specifications in ICAO Annex 14 were based on the layouts of airfields that existed at the time—mostly military airfields—that were deemed to be examples of best practice. It is not uncommon to see older airports with runways from 98 to 197 ft (30 to 60 m) wide. Similarly, the circulation taxiways were separated from the runways so that aircraft on the taxiway did not cause major risk to aircraft landing or taking off from the runway.

Since then, numerous ICAO studies, undertaken with assistance from ICAO technical panels and study groups, have fine-tuned the specifications as actual aircraft performance results and airport experience have become available. Improvements in aircraft manufacturing technology, better training, and the availability of modern visual aids have also contributed to this fine-tuning.

The broad principles governing airfield separations are explained in greater detail in the following sections.

Separation Distance between a Runway and a Taxiway

A parallel taxiway is located such that no part of the largest aircraft expected to operate on the parallel taxiway would penetrate into the adjacent runway strip. This is intended to accommodate any potential veer-off of a landing aircraft when the taxiway is being used and also to provide a sterile area, free of obstacles that may endanger an aircraft executing a missed approach or balked landing maneuver. The separation distance is expressed as follows:

$$S_{\text{RWY-TWY}} = \frac{SW}{2} + \frac{WS}{2}$$

where

$S_{\text{RWY-TWY}}$ is the distance between the centerlines of a runway and a parallel taxiway,

SW is the runway strip width, and

WS is the aircraft wingspan.

Figure 5 depicts the main factors in the ICAO rationale.

Although a link taxiway for entry into and exit from the runway is located within the runway strip, whenever the runway is in use, an aircraft on a link taxiway is required to stop and hold at a distance of 295 ft (90 m) from the runway centerline (ICAO Code E) (ICAO, 2004). For aircraft designated ICAO Code F, where the wingspan is greater than 213 ft (65 m) but not more than 262 ft (80 m), the holding position location is at a distance of 350 ft (107 m) from the runway centerline (ICAO, 2004). This distance may need to be increased for certain operational conditions, and this minimum holding distance should be reviewed if it interferes with radio navigational aids provided for the runway.

The separation distances between a runway and fixed objects other than visual aids required for air navigation purposes are the following (ICAO, 2006a):

- Within 254 ft (77.5 m) of the runway center line of a precision approach runway Cat I, II, or III where the code number is 3 or 4 and the code letter is F;

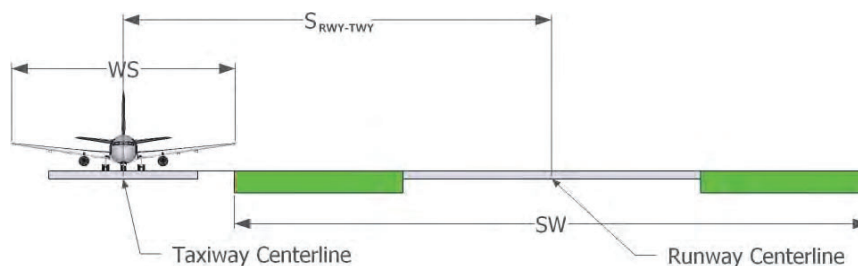

Figure 5. Runway/parallel taxiway separation distance.

- Within 197 ft (60 m) of the runway centerline of a precision approach runway Cat I, II, or III where the code number is 3 or 4; and
- Within 148 ft (45 m) of the runway centerline of a precision approach runway Cat I where the code number is 1 or 2.

In addition, no mobile object shall be permitted on this part of the runway strip during the use of the runway for landing or takeoff.

Separation Distance between a Taxiway and Another Taxiway

Taxiways are vital facilities of an airport on and around which certain safety areas must be provided at all times to ensure that a taxiing aircraft does not collide with another aircraft or an object. A primary assumption here is that an aircraft taxiing on a taxiway may deviate from its centerline; thus, using a “permissible” deviation, the taxiway strip width and taxiway width are determined. The taxiway strip, like the runway strip, should be clear of objects that may endanger taxiing aircraft. Furthermore, all other taxiways and objects that need to be on the operational areas of an airport are built to meet these criteria.

For two aircraft traveling in opposite directions on two parallel taxiways, it initially was deemed appropriate to provide for deviations of both aircraft from their respective centerlines toward each other. It was considered necessary to ensure that in such deviations there was still an adequate safety margin between the wingtips. While the permissible value of the deviation of an aircraft from the taxiway centerline is one factor, abnormal conditions like steering malfunctions, very slippery pavement conditions, low visibility, and poor markings could not be ruled out. Thus, the concept of a safety buffer was introduced to provide an additional safety margin to the separation distance.

The safety buffer, Z , is equal to the difference between the half width of the taxiway strip and the semi-wingspan of the largest aircraft in a given category (whose outer wheel is located at the edge of the paved taxiway, in other words, full deviation

as permitted and added to the semi-wingspan). The safety buffer illustrated in Figure 6 is determined using the following equation:

$$Z = TCS - WS - C$$

where

Z is the safety buffer,

TCS is the taxiway centerline separation,

WS is the aircraft wingspan, and

C is the clearance between the outer main gear wheel and the taxiway edge (maximum allowable lateral deviation).

When deriving this specific dimension for Code F aircraft, it was considered that the steering mechanism of the Code F aircraft would not be worse than that of the Code E aircraft and, thus, the same deviation value of 15 ft (4.5 m) was retained. However, because it was felt that the wider, swept-back wings of modern aircraft might not permit a pilot in the cockpit to see where the wingtip would be, the safety buffer was increased in proportion to the wingspan increase vis-à-vis that for a Code E aircraft.

Separation Distance between Taxiway and Object

The separation distance between the taxiway and a stationary object is specified in order to ensure that a taxiing aircraft’s wingtip does not collide with any stationary object. Because the object is not moving, only one deviation of the aircraft itself is taken into account along with the safety buffer, which includes all other factors that may cause further deviation of the taxiing aircraft. The relationship illustrated in Figure 7 is expressed as follows:

$$S_{\text{TWY-OBJ}} = \frac{WS}{2} + C + Z$$

where

$S_{\text{TWY-OBJ}}$ is the separation,

WS is the wingspan,

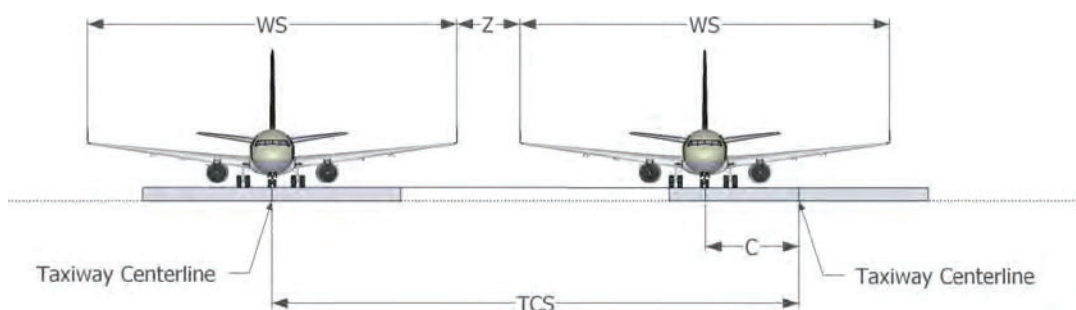

Figure 6. Parallel taxiway separation geometry.

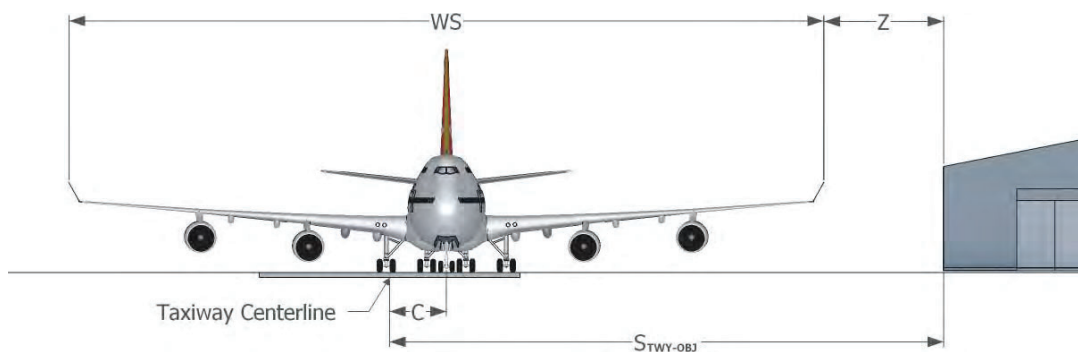

Figure 7. Taxiway/apron taxiway-to-object geometry.

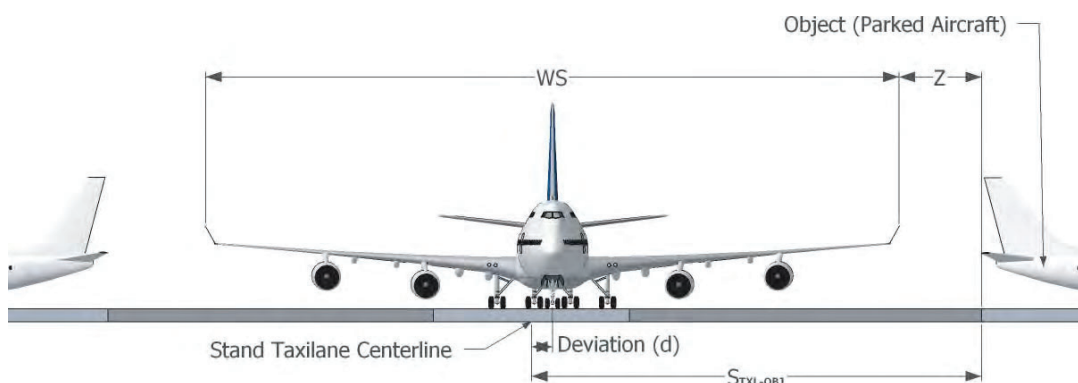

Figure 8. Aircraft stand taxilane-to-object geometry.

C is the clearance between the outer main gear wheel and the taxiway edge (maximum allowable lateral deviation), and

Z = safety margin distance (for example, 10.5 m and 13 m for aircraft Codes E and F, respectively).

Separation Distance between a Taxilane and an Object

For the clearance distance required on an aircraft taxilane, the safety margins are reduced due to the slow taxiing speed of aircraft and the availability of a visual docking guidance system or a marshaller to accurately guide the aircraft. The condition is illustrated in Figure 8. Therefore, for Code E aircraft operations, the C value was reduced to 8 ft (2.5 m) and the safety buffer (Z) was reduced to 25 ft (7.5 m). The formula is the same as the formula for the distance between a taxiway and an object.

$$S_{\text{TXL-OBJ}} = \frac{WS}{2} + C + Z$$

where

$S_{\text{TXL-OBJ}}$ is the separation distance between the taxilane centerline and an object.

In the case of Code F aircraft, again the 1.6-ft (0.5-m) increase in the Z value was engineering judgment to account for the larger wingspan aircraft.

For taxiways and taxilanes, the same document establishes that the minimum separation distance is equal to the wingspan plus max lateral deviation plus increment. ICAO Annex 14—Aerodromes (2006b) contains the standards and recommended practices on airport separations.

CHAPTER 3

Data for Modeling Aircraft Deviations

Airfield Lateral Deviation Studies

During the course of study, an attempt was made to obtain data on extreme lateral aircraft deviations for runways, taxiways, and taxilanes. Also, information was gathered from previous studies and lateral deviation data and models to determine the best alternatives to use in the approach and the methodology to evaluate airfield separations. [Appendix C](#) provides a summary of this literature review.

Ensuing sections of this report provide summaries of data collected in this research and describe previous studies evaluating the magnitude of lateral aircraft deviations during airfield operations as well as the attempts to model the probability distributions of these lateral deviations.

A major consideration is random lateral deviations of aircraft during runway, taxiway, and taxilane operations. The probability distribution of such deviations relative to the centerline/guideline of runways and taxiways is crucial to assessing the adequacy of existing separation/clearance distances for safe and regular operation of aircraft, both on straight portions and on taxiway curves. The following factors may impact those deviations (Eddowes, Hancox, and MacInnes, 2001):

- Quality of aircraft nose wheel guidelines (marking and lighting)
- Quality of signs
- Visibility conditions
- Level of light (day or night)
- Surface condition (dry, wet, contaminated by snow/ice, rubber, etc.)
- Approach speed and touchdown location
- Taxi speed
- Pilot's attention
- Pilot's technique during landing
- Stability of approach
- Pilot's technique on negotiation turns
- Wind effects (cross-wind)

- Aircraft handling characteristics
- Mechanical failures

In the 1970s, the FAA and the U.S. Army Corps of Engineers (USACE) carried out substantial studies on lateral distribution of aircraft traffic on runways and taxiways (Brown and Thompson, 1973; HoSang, 1975). More recently, Cohen-Nir and Marchi (2003), the FAA, and Boeing (Scholz, 2003a and 2003b) performed statistical analyses of taxiway deviations for large aircraft at John F. Kennedy International Airport (JFK) and Ted Stevens Anchorage International Airport (ANC).

Veer-Off Accidents and Incidents

Both the FAA and ICAO address the probability of aircraft veer-offs in their rationale for runway/taxiway separations. ICAO (2004) emphasizes that runway separation issues are supported by local airport experience in terms of identifying causes and accident factors specific to the local environment. No less important is the enormous variety and complexity of accident factors for collision risk.

One of the subtasks of this project was to carry out a functional hazard analysis (FHA) for aircraft veer-offs based on information gathered in the literature review. The objective of this subtask was to identify relevant factors associated with such events to support the data collection effort for accidents and incidents. The research team collected information that could be used in the modeling process, particularly data on causal factors and aircraft location. Identifying the most relevant factors causing or contributing to such events also was part of the modeling process.

An FHA is a formal and systematic process for the identification of hazards associated with an activity that is typically employed to support risk assessment and management. An FHA is often conducted in the form of a brainstorming workshop involving a multi-disciplinary team that could include pilots, air-traffic controllers, airside operations personnel, and

specialist risk assessors. The objective of the FHA is to explore relevant operational scenarios and identify hazards associated with them. The output of the FHA is typically a “hazard log,” which includes all hazards identified and preliminary information about them that can be provided by the workshop team.

A recent study developed by the Flight Safety Foundation (2009) gathered information worldwide on runway excursion accidents occurring from January 1995 to March 2008. The study presents a matrix of contributing factors that identified common causes and followed trends. The study resulted in the following major conclusions.

The major contributing factors for takeoff excursions include the following:

- Rejecting takeoff after V1 was the most cited factor, which in turn was caused by
 - Pilot’s perception of a catastrophic failure
 - Inability to rotate due to incorrect center of gravity (CG) location, mistake in performance calculation, or flight control anomalies
- Loss of directional control, which is generally associated with
 - Mechanical anomalies (30 percent of cases)
 - Contaminated runways
 - Crosswind

The major contributing factors for landing excursions include the following:

- Human errors and neglect of standard operating procedures such as
 - Landing long and/or fast during unstabilized approaches
 - Failing to go around despite unstabilized approach
 - Other pilot’s errors, such as hard landing
- Mechanical problems leading to the following:
 - Spontaneous collapse of the landing gear
 - Asymmetric forces due to thrust reverse or braking problems
- Environmental factors such as the following:
 - Crosswind and tailwind conditions
 - Runway surface under wet or contaminated conditions

Information on runway, taxiway, and taxilane events was not readily available to use in this study. Relevant accident and incident reports were identified in worldwide databases. The basic idea was to collect information that could be used to develop risk models based on evidence from past accidents and incidents. Runway and taxiway veer-off accident and incident data were collected from the following sources:

- FAA Accident/Incident Data System (AIDS)
- FAA/National Aeronautics and Space Administration (NASA) Aviation Safety Reporting System (ASRS)

- National Transportation Safety Board (NTSB) Accident Database and Synopses
- Transportation Safety Board of Canada (TSB)
- Australian Transport Safety Bureau (ATSB)
- Bureau d’Enquêtes et d’Analyses pour la Sécurité de l’Aviation Civile (BEA)
- UK Air Accidents Investigation Branch (AAIB)
- New Zealand Transport Accident Investigation Commission (TAIC)
- Air Accident Investigation Bureau of Singapore
- Ireland Air Accident Investigation Unit (AAIU)
- Spain’s Comisión de Investigación de Accidentes e Incidentes de Aviación Civil (CIAIAC)
- Indonesia’s National Transportation Safety Committee (NTSC)
- Netherlands Aviation Safety Board (NASB)
- MITRE Corporation Accident and Incident Database

A list of accidents and incidents containing the cases used for model development is presented in [Appendix D](#). In addition to the taxiway incidents identified, the list includes runway veer-off events that occurred within 1,000 ft of the runway centerline. Every identified event that has occurred since 1978 and for which reports were available was included in the database for this study.

Portions of the data are complemented with other sources of information, particularly information sources on aircraft, airport, and meteorological conditions. For example, in many cases information on the weather during the accident was missing, and the research team obtained the actual METAR for the airport to retrieve the data. In other situations, the runway used was missing, and the research team consulted the FAA Enhanced Traffic Management System Counts (ETMSC) and the Aviation System Performance Metrics (ASPM) to retrieve relevant information.

Additional filtering criteria were used so that the events were comparable. The first set of filtering criteria was applied so as to retrieve only information from regions of the world having accident rates that are comparable to the U.S. rate. In addition, the filtering criteria described in Table 3 were applied in this study. Filtering was necessary in order to make data collection a feasible task and to ensure that the data used in the modeling process were fairly homogeneous.

Aircraft Veer-Off Database Organization

The accident and incident database was developed in Microsoft Access. The system provides the software tools needed to utilize the data in a flexible manner and includes facilities to add, modify, or delete data from the database;

Table 3. Filtering criteria for accidents and incidents.

Filter #	Description	Justification
1	Remove non-fixed-wing aircraft entries.	Study is concerned with fixed-wing aircraft accidents and incidents only.
2	Remove entries for airplanes with certified max gross weight < 6,000 lb.	Cut-off criteria to maintain comparable level of pilot qualifications and aircraft performance to increase the validity of the modeling.
3	Remove entries with unwanted Federal Aviation Regulation (FAR) parts. Kept Part 121, 125, 129, 135, and selected Part 91 operations.	Some FAR parts have significantly different safety regulations (e.g., pilot qualifications). The following cases were removed: <ul style="list-style-type: none"> - Part 91F: Special Flt Ops - Part 103: Ultralight - Part 105: Parachute Jumping - Part 133: Rotorcraft Ext. Load - Part 137: Agricultural - Part 141: Pilot Schools - Armed Forces
4	Remove occurrences for unwanted phases of flight.	Study focus is the RSA. Situations when the RSA cannot help mitigating accident and incident consequences were discarded to increase model validity.
5	Remove all single-engine aircraft and all piston-engine aircraft entries.	Piston-engine aircraft are used infrequently in civil aviation and have been removed to increase the validity of the modeling. Moreover, single- and piston-engine aircraft behave differently in accidents due to the lower energy levels involved. Finally, the major focus of this study is air carrier aircraft.
6	Remove all accidents and incidents when the wreckage final location is beyond 1,000 ft from runway centerline.	It would be infeasible to have an RSA more than 1,000 ft from the runway centerline; the gain in safety is not significant.

make queries about the data stored in the database; and produce reports summarizing selected contents. Figure 9 illustrates the database organization.

The database includes for each individual event or operation the reporting agency, the characteristics of the aircraft involved, the runway and environmental conditions, event classification (accident or incident), and other relevant information such as consequences (fatalities, injuries, and damage) and causal or contributing factors. A unique identifier was assigned to each event.

Normal Operations Data (NOD)

Another key approach in this study was the use of normal operations (i.e., non-accident/incident flight) data for probability modeling of runway veer-offs. In the absence of information on risk exposure, even though the occurrence of a factor (e.g., contaminated runway) could be identified as a contributor to many accidents, it is impossible to know how critical the factor was since other flights may have experienced the factor without incidents. With NOD, the number of opera-

tions that experience the factor benignly, singly, and in combination can be calculated; risk ratios can be generated; and the importance of risk factors can be quantified. This assessment may allow the prioritization of resource allocation for safety improvement.

The NOD from the research reported in *ACRP Report 3: Analysis of Aircraft Overruns and Undershoots for Runway Safety Areas* was used in this study (Hall et al., 2008). The database was complemented with data for general aviation (GA) aircraft with a maximum takeoff weight (MTOW) of less than 12,500 lb and greater than 6,000 lb. These data are a large and representative sample of disaggregated U.S. NOD covering a range of risk factors associated with runway veer-offs, allowing their criticality to be quantified. The data on U.S. incidents and accidents were used as a sample to develop the frequency models for runway veer-offs only. A sample of the NOD data is available in [Appendix E](#).

Incorporating this risk exposure information into the accident frequency model enhances its predictive power and provides the basis for formulating more risk-sensitive and responsive RSA assessments. Accident frequency models no

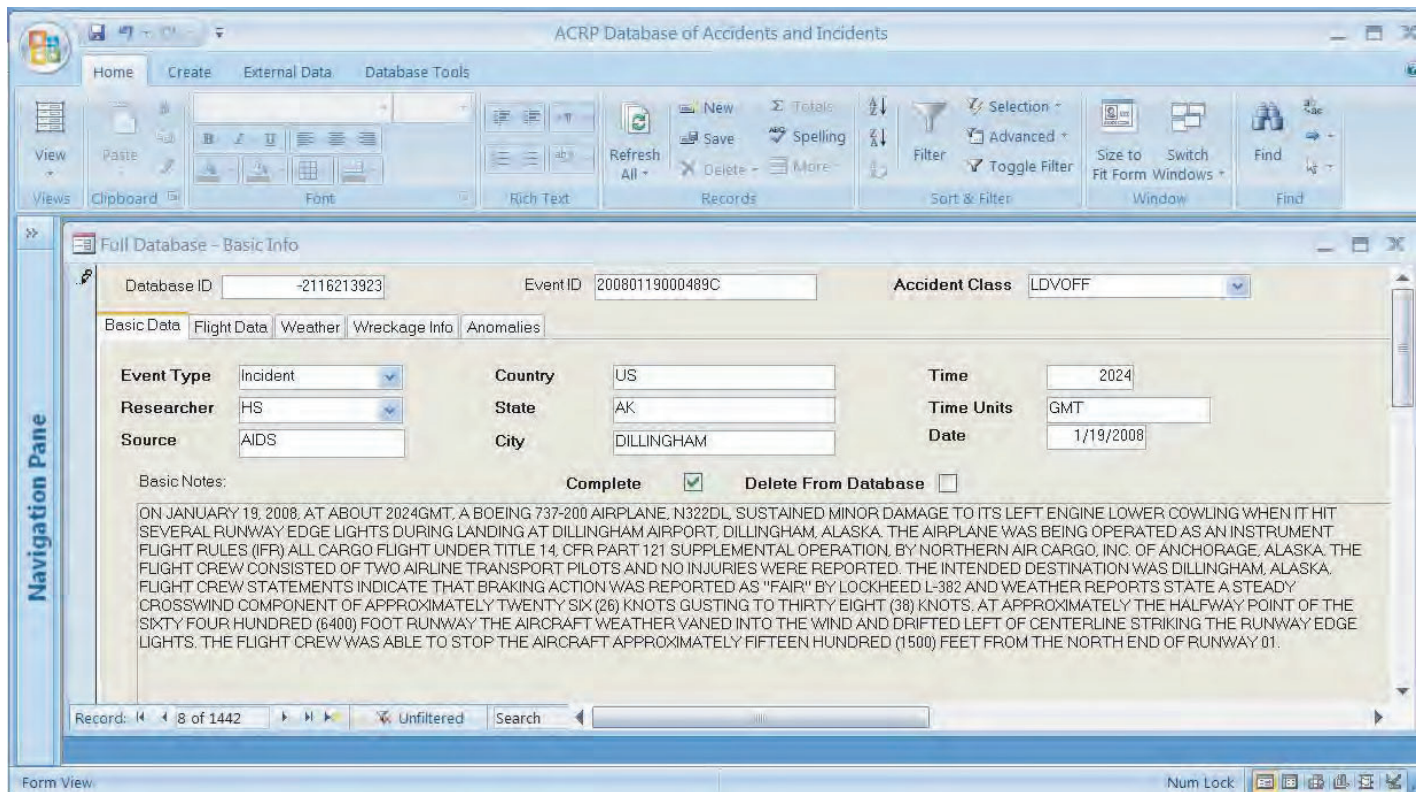

Figure 9. Accident and incident database for aircraft veer-offs.

longer need to rely on simple crash rates based on only aircraft, engine, or operation type.

Aircraft Data

The runway veer-off models incorporate an important factor to address the impact of aircraft performance and available runway length on the probability of veer-off incidents. For many of these events, particularly those taking place during the landing phase, if the runway length available is close to the runway length required by the aircraft for the operation, there may be a higher probability that a veer-off will take place because the safety margin is lower and more intense braking is required.

Two factors were included in the models that required additional data on aircraft performance: the runway distance available for the operation (takeoff or landing) and the air-

craft runway distance required for the operation. The runway distance available was gathered for each accident, incident, and normal operation based on airport data.

Aircraft performance data were gathered from various sources, including aircraft manufacturers' websites and the following databases:

- FAA Aircraft Characteristics Database
- Eurocontrol Aircraft Performance Database V2.0
- FAA Aircraft Situation Display to Industry—Aircraft Types
- Boeing Airplane Characteristics for Airport Planning
- Airbus Airplane Characteristics for Airport Planning
- Embraer Aircraft Characteristics for Airport Planning

Aircraft performance data were used to develop the probability models. A summary of the aircraft database is presented in Appendix F.

CHAPTER 4

Methodology Approach

The basic goal of this study was to develop a methodology to evaluate airfield separations. There are a few different scenarios for the analysis of airfield separations, and each requires a different set of models and a specific procedure for the analysis. For example, the evaluation of a separation between a runway and a parallel taxiway requires a different set of models than a separation between a taxiway and an object.

The methodology presented in this report is applicable only to runways and straight parallel sections of taxiways and taxilanes and to straight sections of taxiways and taxilanes when the separation involves an object. The methodology also assumes that the pilot has full directional control of the aircraft, a good visual indication of the taxiway/taxilane centerline, and no assistance from a marshaller. The following are the types of separations that may be evaluated with the methodology:

- Taxiway to parallel taxiway
- Taxiway to parallel taxilane
- Taxiway to object
- Taxilane to parallel taxilane
- Taxilane to object
- Runway to parallel taxiway or taxilane
- Runway to object

The bases for the developed approach are the random lateral and vertical (airborne phase) deviations that may occur during normal operations and veer-off incidents. The risk of collision is related to the probability of large deviations from the nominal flight path and from the runway, taxiway, and taxilane centerlines when aircraft are moving on parallel routes.

Despite intensive efforts to identify taxiway and taxilane incidents, it was not possible to develop two-part models (frequency and location) for taxiway and taxilane veer-offs due to the difficulty in obtaining location data for close to 300 incidents occurring in straight segments of taxiways and very few relevant incidents occurring on taxilanes. However, it was noted that taxiway and taxilane incidents due to aircraft deviations do not lead to departures from the paved area of large

distances. In the great majority of the cases, the pilots immediately stopped the aircraft when the aircraft departed the paved area. The following assumptions can be made regarding taxiway operations:

- Aircraft travel at slower speeds relative to runway operations;
- The end of the paved area is a discontinuity that signals to pilots that they are off the taxiway;
- Because the aircraft is traveling slower, the pilot usually has some control and can stop the aircraft almost immediately after departing the taxiway;
- These three factors combined lead to the assumption that the location probability distribution can be truncated for non-ramp taxiways.

Most taxiway and taxilane incidents and accidents occurred in curved segments or because another aircraft or ground equipment was located inside the taxiway or taxilane OFA. In most cases, events with large lateral deviations occurred during poor weather conditions and situations of low surface friction (low visibility, rain, and ice).

Modeling of aircraft lateral and vertical deviations on the runway involved different phases of flight, and for each phase a specific model was developed or used. For approach and landing, the airborne phase was modeled using the FAA/ICAO CRM, and for the rollout phase after aircraft touchdown, a two-part model (frequency and location) was developed and is described in ensuing sections. During takeoff, the factors and risk of veer-off are different from the models for landing, and another set of models (frequency and location) was required for this phase of flight.

Taxiway and Taxilane Deviation Modeling

Initially, the approach for modeling taxiway deviations was a two-part model composed of a frequency model and a location model. Taxiway veer-off incident data were collected to

obtain information on causal and contributing factors (visibility, taxiway surface conditions, etc.) to develop a frequency model to estimate the chance of taxiway veer-off incidents occurring under certain conditions. In addition, it was initially thought that lateral deviation information for those incidents should be collected to develop location models, particularly for aircraft that departed the paved taxiway area. With these two models, it would be possible to estimate the likelihood of an incident occurring with a lateral deviation greater than a certain distance from the taxiway edge. Although enough information was available from the data collection exercise to develop frequency models, information on incident location and deviations was not available.

A couple of observations led to the conclusion that a two-part frequency/location model was not the best approach for modeling taxiway veer-off incidents and the possibility of aircraft collisions with other aircraft and fixed or movable objects. The first observation was that historical taxiway collision events were not related to taxiway deviations; in almost every case, the collision occurred because another aircraft or movable object was inside the wing path of the taxiing aircraft. The second observation was that when a taxiway veer-off occurred, the aircraft stopped immediately after it departed the paved taxiway area.

Therefore, the combination of frequency and location models will only help to estimate the probability that the aircraft will stop off the taxiway paved area, and it will not be possible to quantify the risk of wingtip collisions associated with large deviations to evaluate the taxiway separation. In addition, very few incidents were found to occur when the pilot had control of the aircraft. For taxiways, even the frequency model could not be developed due to the lack of cases with which to build a database.

The alternative selected was to use the taxiway deviation models developed by FAA/Boeing (Scholz, 2003a and 2003b). The approach and models proved to be in line with the goals for this project. [Appendix G](#) provides a summary of the methodology and results from the FAA/Boeing studies. The first report describes the study and deviation models for John F. Kennedy International Airport (JFK), the second describes the study for Ted Stevens International Airport (ANC), and the third combines the deviation models from both studies and describes the models for risk of wingtip collision between two aircraft and between an aircraft and an object. The collision risk between two taxiing aircraft can be estimated using the mean wingtip distance between the two aircraft, in other words, the wingtip clearance when both aircraft are located on the taxiway centerlines.

The deviations at each airport were extrapolated to more extreme deviations as they could happen for significantly higher numbers of event exposures, for example, $10^6 - 10^9$ taxiway operations. Based on the extreme value limiting assumption, absolute deviations were extrapolated using the 700 most

extreme deviations at ANC and 200 most extreme deviations at JFK. The model resulting from the analysis was in the following general form:

$$p = 1 - \exp\left(-\frac{1}{n}\left[1 + c\left(\frac{y - \lambda}{\delta}\right)\right]^{-1/c}\right)$$

where

- y is the specified threshold of exceedence,
- p is the probability estimate of exceeding the threshold y distance from the centerline, and
- λ , δ , n , and c are extrapolation parameters for the model.

Cohen-Nir and Marchi (2003) conducted another study using the data collected from JFK and ANC. In processing the JFK deviation data, they identified some problems with the data collected. Several large deviations that would have put the B-747 outside of the taxiway were recorded in a very short period of time. One of the lasers used in the FAA experiment had gone out of service, and all subsequent unusually large deviations occurred with only one laser in service and no ability to measure speed, wheelbase, or direction of travel. Because of the anomalies associated with the data collected from JFK, only the models developed for ANC were used in the airfield separation analysis methodology for this study.

To avoid collision between two taxiing aircrafts with WS_1 and WS_2 wingspans, the combined deviations need to satisfy the following equation:

$$T_{\text{TWY-TWY}} > (WS_1 + WS_2)/2 + d_1 + d_2$$

where

- $T_{\text{TWY-TWY}}$ is the required separation between the taxiway centerlines and
- d_1 and d_2 are the deviations of each aircraft, as shown in Figure 10.

A collision between an aircraft wingtip and a fixed or movable object can be avoided if:

$$T_{\text{TWY-OBJ}} > WS/2 + d$$

where

- $T_{\text{TWY-OBJ}}$ is the separation between the object and the taxiway centerline,
- WS is the wingspan, and
- d is the aircraft deviation from the taxiway centerline.

This situation is presented in Figure 11.

One important observation when using the models developed with data gathered from ANC and JFK is that taxiway centerline lights were available in all taxiway sections that were monitored. Therefore, probability distributions characterizing those deviations rely on the conspicuity of taxiway centerlines. An important risk control recommendation when using

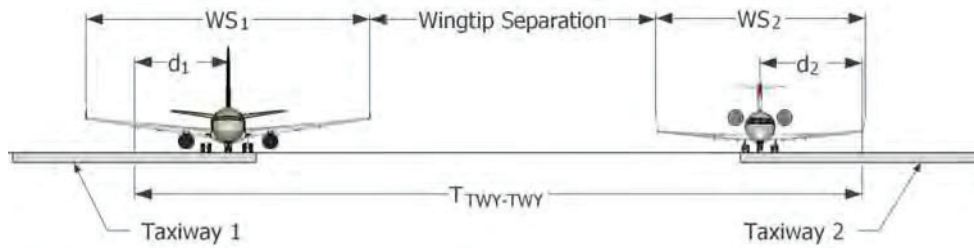

Figure 10. Taxiway/taxiway separation.

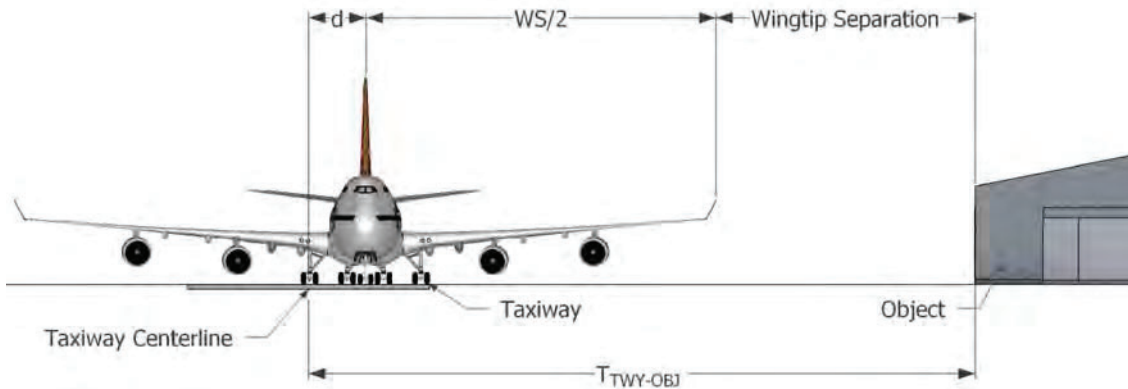

Figure 11. Taxiway/object separation.

this methodology is the assurance that taxiway centerlines will be evident under any conditions when using the taxiways.

Taxiway/Taxiway Separation

The analysis procedure for taxiway/taxiway separation is based on the models presented in the FAA/Boeing study to assess taxiway/taxiway collision probabilities, which are based on the wingtip separation of two aircraft located at the centerlines of two parallel taxiways (Scholz, 2005). In this approach, lateral deviations were split into two halves, and the deviations from the first half were randomly paired with deviations from the second half. In all, 6,157 pairs of $d_1 + d_2$ were obtained. For each set of such pairs, the extreme value extrapolation method was applied to the absolute value of $|d_1 + d_2|$ to obtain estimates of deviation probabilities. To correct for random splitting and pairing effects, the process was repeated 500 times, and a combined estimate with confidence bounds was obtained.

Table 4 presents the probability results, which were applied to the procedure to evaluate taxiway/taxiway separations described in this report. Table 4 presents the probability of wingtip collision based on the separation between taxiway centerlines and the wingspan distance. To facilitate the analysis, plots were developed for each Aircraft Design Group (ADG) based on the maximum wingspan for the specific ADG.

Although the data used to develop the lateral deviation models were collected for the B-747 only, the same models were used to develop risk plots for aircraft belonging to other ADGs. This is a conservative assumption because smaller deviations are expected for smaller aircraft.

The data presented in Table 4 were converted to a plot based on the wingtip separation, which is presented in Figure 12.

Table 4. Required separation between taxiway centerlines.

wingspan (ft)	Estimate $\leq T$ (ft)						
	collision risk p						
	10^{-3}	10^{-4}	10^{-5}	10^{-6}	10^{-7}	10^{-8}	10^{-9}
180	189.4	191.6	193.8	195.9	197.8	199.7	201.4
190	199.4	201.6	203.8	205.9	207.8	209.7	211.4
200	209.4	211.6	213.8	215.9	217.8	219.7	221.4
210	219.4	221.6	223.8	225.9	227.8	229.7	231.4
220	229.4	231.6	233.8	235.9	237.8	239.7	241.4
230	239.4	241.6	243.8	245.9	247.8	249.7	251.4
240	249.4	251.6	253.8	255.9	257.8	259.7	261.4
250	259.4	261.6	263.8	265.9	267.8	269.7	271.4
260	269.4	271.6	273.8	275.9	277.8	279.7	281.4
270	279.4	281.6	283.8	285.9	287.8	289.7	291.4
280	289.4	291.6	293.8	295.9	297.8	299.7	301.4

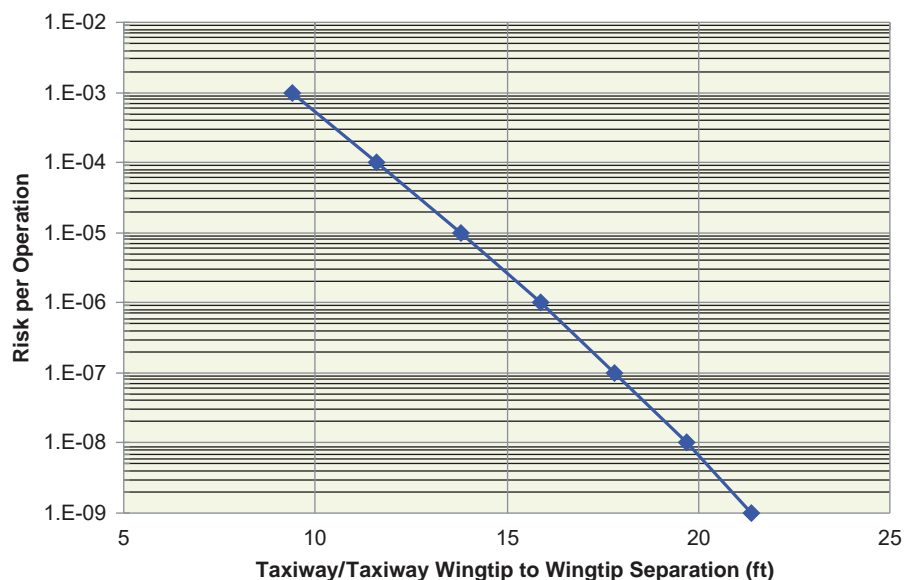

Figure 12. Taxiway/taxiway collision risk.

The same taxiway/taxiway separation models are used to evaluate taxiway/taxilane separations. The estimates of risk for this situation are considered conservative since the speed of aircraft is usually slower in taxilanes and deviations are expected to be smaller than they are for taxiways.

The extrapolation of risk for wingtip separations larger than 25 ft may lead to inaccurate results and very low risks. The standard separation for ADG V is 53 ft; based on the models, the risk for such a condition is lower than 1.0E-15, or one event in one quadrillion operations. This is no surprise, as there are no reports of wingtip collisions between two aircraft on parallel taxiways. In the accident and incident data collected, no record was found for wingtip collisions between two aircraft in parallel taxiways, and therefore the level of protection provided by the standards may be considered very high.

From the point of view of risk and based on the records of incidents and accidents, the worst credible consequence expected for wingtip collisions of two taxiing aircraft is aircraft damage. In this case, according to the risk matrix recommended by the FAA, the risk is acceptable if it is less than one in 10 million operations (1.0E-07), the same collision risk probability level used by ICAO in CRM analysis.

Taxiway/Object Separation

Using the models based on ANC data developed by FAA/Boeing (Scholz, 2003a), the wingtip collision risk can be derived based on the wingtip separation from an object when the aircraft is located at the taxiway centerline. Using this approach provides more flexibility to the analysis for specific aircraft wingspans, rather than considering the largest wingspan in the

ADG. As shown in Figure 11, wingtip separation is the distance of the object from the centerline of the taxiway less half of the operating aircraft wingspan. Collision happens only if the deviation of the aircraft exceeds this distance to the side of the taxiway where the object is present. One simplifying assumption is necessary: the wingtip deviation distribution is the same as the aircraft lateral deviation distribution from the taxiway centerline.

Using data from the FAA study, it is possible to estimate the probability of taxiway-object collision based on the mean wingtip separation; in other words, the separation when both aircraft are located at the respective taxiway centerlines (Scholz, 2003a). The basic assumption in this case is that lateral deviations are similar, independent of the type of aircraft. Although this cannot be proved using existing data, the assumption is conservative because the data used to model risk were gathered for large aircraft.

The resulting model based on taxiway deviation data collected at ANC is presented in Figure 13.

Taxilane/Taxilane Separation

Aircraft deviation data or studies were not available to develop probability models for taxilane deviations. The data collection exercise carried out for this research identified a few taxilane veer-off incidents, and insufficient information was available to develop any lateral deviation models. Records of taxilane accidents demonstrate that, in most cases, another aircraft or movable object was parked or located inside the taxilane OFA. Therefore, the occurrence could not be considered a “taxilane deviation” case, and it could occur independently of the existing taxilane separation.

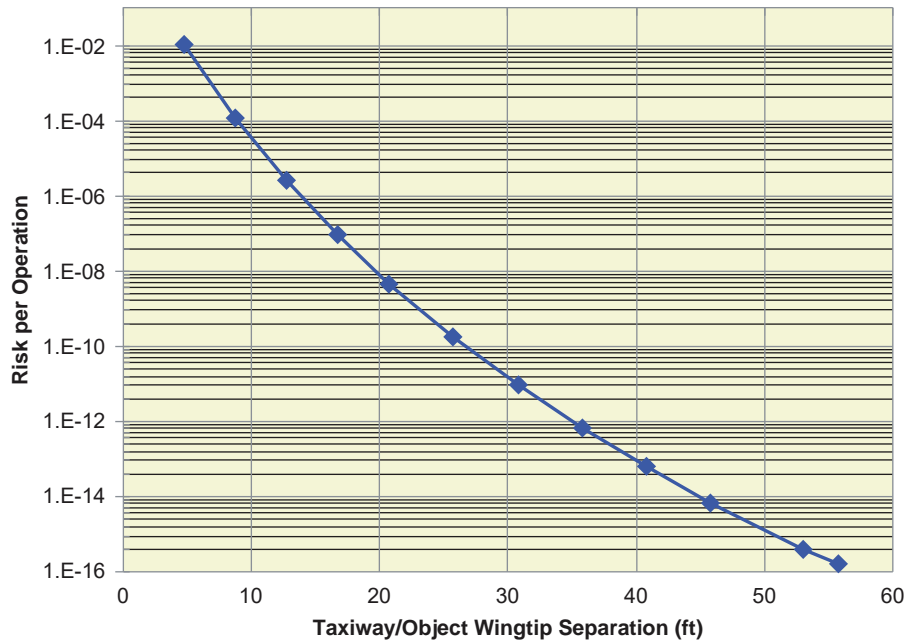

Figure 13. Taxiway/object collision probability based on wingtip separation.

FAA established separation criteria for taxilanes and taxiways and made changes in 1989 (FAA, 1989). These standards are based on aircraft design categories. There is no reference describing the quantitative basis for the criteria, and it is likely that engineering judgment was used to define those standards.

Both the FAA and ICAO recognize that aircraft deviations in taxilanes are usually smaller than those occurring in taxiways. Aircraft taxiing in taxilanes are moving at very low speeds, and pilots are usually very focused on parking operations in areas where movable objects are common.

For the approach presented in this report, the ratios of wingtip separations of taxiway/taxiway to taxilane/taxilane for each ADG were calculated. As shown in Table 5, the ratios varied from 0.75 for ADG I to 0.58 for ADG V and VI.

These ratios were used to adjust the models used for taxiway/taxiway separations developed by the FAA. The rationale is that the risk for veering off a taxilane OFA should be similar to or lower than the risk of veering off a taxiway. Therefore,

Table 5. Taxiway/object and taxilane/object mean wingtip separations for aircraft design groups.

Item	ADG Distances in ft					
	I	II	III	IV	V	VI
Taxiway/Object Wingtip Separation	20	26	34	44	53	62
Taxilane/Object Wingtip Separation	15	18	22	27	31	36
Ratio	0.75	0.69	0.65	0.61	0.58	0.58

the wingtip to wingtip separation distances associated with each level of risk for taxiways was adjusted using the ratio corresponding to the ADG. For example, a ratio of 0.58 was applied to the model for lateral deviations on taxiways for ADG V. The resulting model is illustrated in Figure 14.

The plot shows the risk trend for taxilane/taxilane separation of ADG V aircraft based on the mean wingtip separation (i.e., based on the wingtip distance when both aircraft are located on the centerlines of parallel taxilanes). The standards for taxilane separations are considered conservative, given the lack of recorded taxilane incidents associated with lateral deviations.

Figures similar to Figure 14, based on separation between taxilane centerlines, were developed for each ADG based on the ratios presented in Table 6 and the maximum wingspan for the ADG.

Taxilane/Object Separation

Similar to the approach for taxilane/taxilane separations, adjustment factors were applied to the FAA/Boeing models for taxiway/object wingtip separations (Scholz, 2003a). The ratios are the same as those used for the taxilane/taxilane model because the standard wingtip separations between two aircraft and between an aircraft and an object are similar according to AC 150/5200-13 (FAA, 1989).

The standard minimum wingtip to object separation for ADG V in parallel taxilanes is 31 ft and, based on Figure 15, the risk of wingtip collision is lower than 1.0E-09.

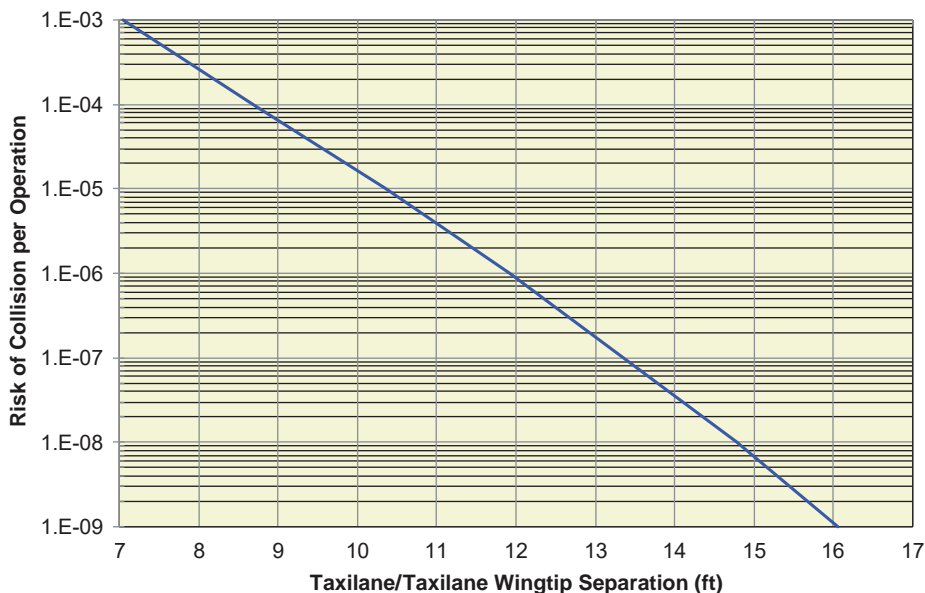

Figure 14. Taxilane/taxilane collision probability based on wingtip separation.

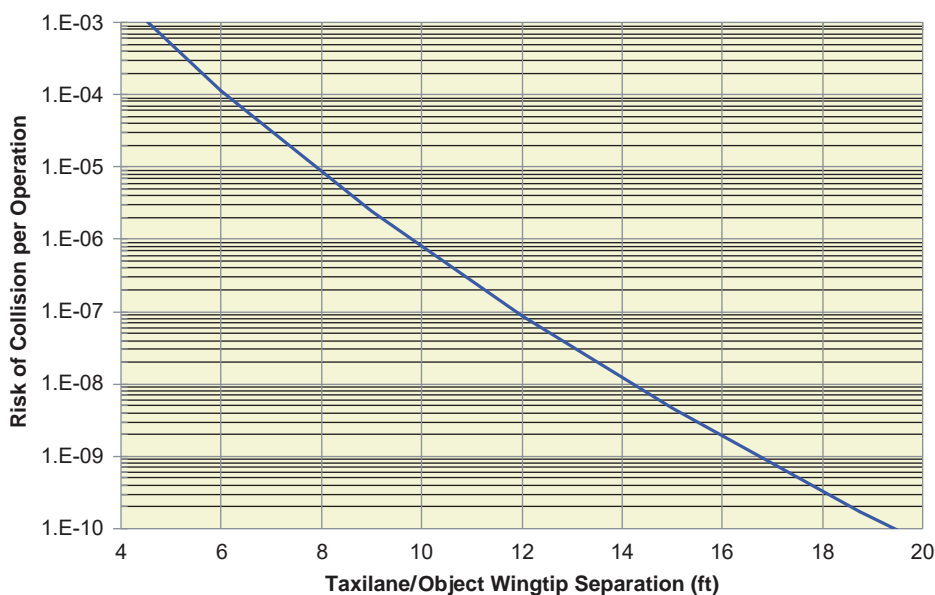

Figure 15. Taxilane/object collision risk based on wingtip separation.

Runway Deviation Modeling

The probability of aircraft collision associated with the separation between the runway and taxiway or objects depends on whether the movement is a landing or a takeoff operation.

For landing there are two types of risk that may be evaluated:

- Risk during the final approach phase when the aircraft is airborne and the combination of large lateral and vertical deviations from the nominal approach path may lead to collision with a fixed or movable object in the airfield area (e.g., an aircraft taxiing in a parallel taxiway).

- Risk if the aircraft loses directional control after touching down and veers off the runway, colliding with fixed or movable objects.

These two types of risk may be combined to provide the total risk for landing. The veer-off risk is estimated for every landing operation, whereas the airborne risk is computed only for missed approaches.

When taking off, the pilot may reject the procedure and intentionally or unintentionally veer-off the runway. If directional control is lost when in high speed, the aircraft may col-

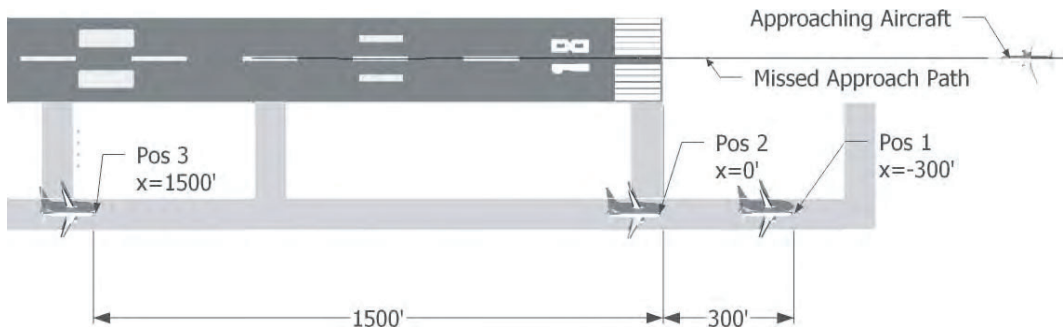

Figure 16. Plan view of CRM run experiment.

lide with fixed or movable objects after departing the runway edge and possibly the RSA.

The methodology used to assess risk during the airborne phase was the CRM. Although the CRM model was developed in the 1970s and the FAA has been improving these models since the 1990s, the original CRM can serve as a screening tool to evaluate the feasibility of submitting an MOS. The FAA has other tools to evaluate the need for further analysis if the risk estimated is within a feasible range. A summary of the CRM approach, variables, and models is provided in [Appendix B](#).

Landing—Airborne Phase Model

It is recognized that running the CRM demands the availability of specific software and the expertise to use it. To facilitate the analysis and the application of the methodology, several CRM runs were made for common situations and different ADGs; however, when the analysis involves specific aircraft rather than an ADG, for the airport to obtain more accurate estimates of risk, the assessment should use direct results from the CRM analysis and specific conditions, if possible.

Several CRM runs were made with obstacles located at various separations from the runway centerline and along the runway length. For Cat I, an obstacle clearance height (OCH) of 200 ft was used, and for Cat II an OCH of 100 ft was used. The ranges used were -300, 0, 1,500, 3,000, and 4,500 ft. Figures 16 and 17 illustrate the experiment run for several runway/taxiway separations. In Figure 16, only ranges of -300, 0, and 1,500 ft are shown.

With the results from the CRM analysis, the maximum risk for each runway/taxiway separation was identified among the five locations along the parallel taxiway. The next step was to develop risk plots for wingtip separation versus risk in terms of accidents per number of operations. The process was repeated for each ADG, and risk plots were prepared for each group and instrument approach Cat 1 and 2.

The approach to estimating risk using the plots presented in Appendix A may be viewed as conservative for the following reasons:

- Only the highest risk along the runway length was used for the estimate of collision risk.

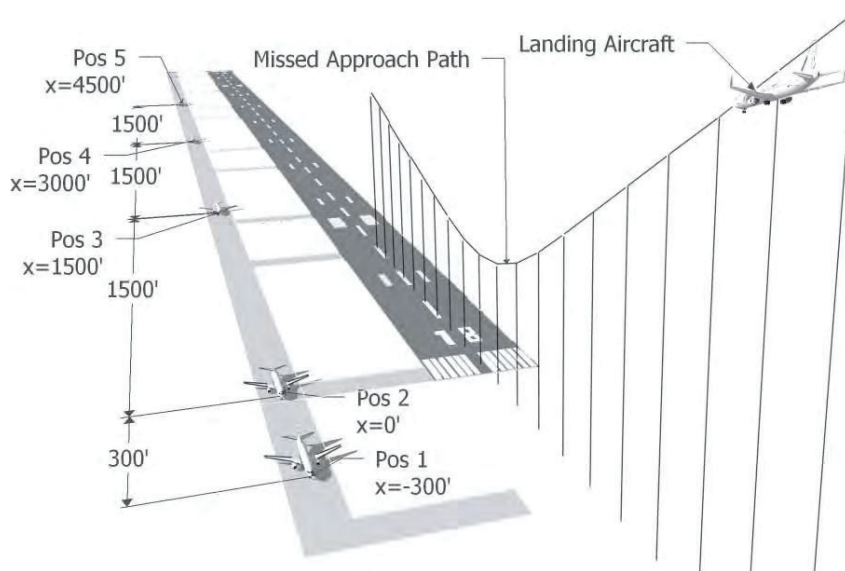

Figure 17. Perspective view of CRM run experiment (not to scale).

- The tallest tail height in the ADG was used to characterize the taxiing aircraft as an obstacle.
- The widest wingspan in the ADG was used to characterize the dimension of the approaching aircraft.
- The taxiing aircraft was assumed to be a fixed object; however, for many airports, a taxiing aircraft will not be present during most of the landings.
- A missed approach rate of 1 percent was kept for the calculations. Based on the latest FAA data, even a 0.2-percent rate is conservative (FAA, 2008).

Runway Veer-Off Models for Landing and Takeoff

During the landing, after touchdown, or during the takeoff roll, the pilot may lose directional control. Some common causes and contributing factors include low runway friction, mechanical failures, and adverse weather conditions.

The basis of the approach used in this study is the probability of aircraft runway excursions and the risk that an aircraft will stop outside the boundaries of the existing or planned RSA. The approach to model risk of collisions is accomplished by using a combination of frequency and location models. In a sense, the modeling considered the bounds of the RSAs rather than the presence of obstacles in the vicinity of the RSAs or the aircraft speed when striking obstacles. While the difference makes the new models simpler, the approach can be extended to consider risk if this type of analysis is required. The two-part model approach is represented in Figure 18.

Event Probability (Frequency Model)

The likelihood of an aircraft veer-off incident depends on operational conditions and human factors. It includes airport characteristics, weather conditions, and aircraft performance, as well as the relationship between the runway distance required by the aircraft for the given conditions and the runway distance available at the airport.

Similar to the approach presented in *ACRP Report 3* (Hall et al., 2008), backward stepwise logistic regression was used to

calibrate the veer-off frequency models. Data were gathered from accidents and incidents and NOD. To avoid the negative effects of multicollinearity on the model, correlations between independent variables were tested to eliminate highly correlated variables, particularly if they did not contribute significantly to explaining the variation of the probability of an accident.

The selected approach can identify relationships missed by forward stepwise logistic regression (Hosmer and Lemeshow, 2000). The predictor variables were entered by blocks, each consisting of related factors, such that the change in the model’s substantive significance could be observed as the variables were included.

The basic model structure used is logistic, as follows:

$$P\{Accident_Occurrence\} = \frac{1}{1 + e^{b_0 + b_1X_1 + b_2X_2 + b_3X_3 + \dots}}$$

where

$P\{Accident_Occurrence\}$ is the probability (0–100%) of an accident type occurring given certain operational conditions, X_i are independent variables (e.g., ceiling, visibility, crosswind, precipitation, and aircraft type), and b_i are regression coefficients.

Several parameters were considered for inclusion in the models. The backward stepwise procedure helps identify the most relevant variables for each type of event. One major improvement relative to models presented in previous studies was the use of tailwind and headwind. These variables were not present in the overrun and undershoot models presented in *ACRP Report 3* (Hall et al., 2008) because the actual runway had not been identified in the NOD. The research team gathered information on the runways used, and the process allowed the calculation of the head/tailwind components of the model.

Another major accomplishment that has increased model accuracy was the inclusion of a runway criticality factor. The new parameter represents the interaction between the runway distance required by the aircraft and the runway distance available at the airport. The logarithm of the ratio between the distance required and the distance available was used to

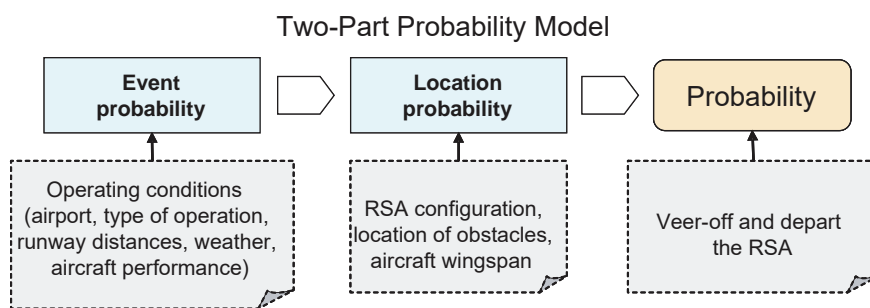

Figure 18. Modeling approach.

represent the criticality factor. The greater the value, the more critical the operation because the safety margin decreases, and in many cases strong braking or the possibility of overruns may lead to veer-off events.

The distance required is a function of the aircraft performance under specific conditions. Therefore, every distance required under International Organization for Standardization (ISO) conditions (sea level, 15 deg centigrade) was converted to actual conditions for operations. Moreover, the distances were adjusted for the runway surface condition (wet, snow, slush, or ice) and for the level of head/tailwind. The adjustment factors for runway surface conditions are those recommended by the Flight Safety Foundation (2009).

To summarize, the runway distance required was adjusted for temperature, elevation, runway surface conditions, and wind. Table 6 presents the factors applied to the distance required by the aircraft. A correction for slope was not applied, as this factor had little effect on the total distance required.

The use of NOD in the accident frequency model was a major improvement introduced in *ACRP Report 3* (Hall et al., 2008), and it was maintained for this study. The analysis with NOD also adds to the understanding of cause and effect relationships for veer-off incidents. Table 7 summarizes the model coefficients obtained for each veer-off frequency model.

Table 8 summarizes the parameters representing the accuracy of each model obtained presenting the R^2 and C -values

Table 6. Correction factors applied to required runway distance.

Local Factor	Unit	Reference	Adjustment	Factor Definitions
Elevation (E) ⁽ⁱ⁾	1000 ft	E = 0 ft (sea level)	$F_e = 0.07 \times E + 1$	F_e is runway distance adjustment factor for elevation
Temperature (T) ⁽ⁱ⁾	deg C	T = 15 deg C	$F_t = 0.01 \times (T - (15 - 1.981 E) + 1$	F_t is runway distance adjustment factor for temperature
Tailwind (TWLDJ) for Jets ⁽ⁱⁱⁱ⁾	knot	TWLDJ = 0 knot	$F_{TWJ} = (RD + 22 \times TWLDJ)/RD$ ⁽ⁱⁱ⁾	F_{TWJ} is runway distance adjustment factor for tailwind (jets)
Tailwind (TWLDT) for Turboprops ⁽ⁱⁱⁱ⁾	knot	TWLDT = 0 knot	$F_{TWP} = (RD + 30 \times TWLDT)/RD$	F_{TWP} is runway distance adjustment factor for tailwind (turboprops)
Headwind (HWTOT) for Jets ⁽ⁱⁱⁱ⁾	knot	HWTOT = 0 knot	$F_{HWJ} = (RD + 6 \times HWTOT)/RD$	F_{HWJ} is runway distance adjustment factor for headwind (jets)
Headwind (HWTOT) for Turboprops ⁽ⁱⁱⁱ⁾	knot	HWTOT = 0 knot	$F_{HWP} = (RD + 6 \times HWTOT)/RD$	F_{HWP} is runway distance adjustment factor for headwind (turboprops)
Runway Surface Condition - Wet (W) ^(iv)	Yes/No	Dry	$F_W = 1.4$	F_W is runway distance adjustment factor for wet pavement
Runway Surface Condition - Snow (S) ^(iv)	Yes/No	Dry	$F_S = 1.6$	F_S is runway distance adjustment factor for snow-covered pavement
Runway Surface Condition - Slush (SI) ^(iv)	Yes/No	Dry	$F_{SI} = 2.0$	F_{SI} is runway distance adjustment factor for slush-covered pavement
Runway Surface Condition - Ice (I) ^(iv)	Yes/No	Dry	$F_I = 3.5$	F_I is runway distance adjustment factor for ice-covered pavement

i - temperature and elevation corrections used for runway design

ii - RD is the runway distance required

iii - correction for wind are average values for aircraft type (jet or turboprop)

iv - runway contamination factors are those suggested by Flight Safety Foundation (2000)

Table 7. Independent variables for veer-off frequency models.

Variable	LDVO	TOVO ¹	Variable	LDVO	TOVO ¹
Adjusted Constant	-13.088	-15.612	Temp from 5 to 15°C	-0.453	-0.420
User Class G	1.682	2.094	Temp more than 25°C	0.291	-0.921
Aircraft Class A/B	-0.770	-0.852	Icing Conditions	2.67	³
Aircraft Class D/E/F	-0.252	-0.091	Rain	-0.126	-1.541
Visibility less than 2 SM ²	2.143	2.042	Snow	0.548	0.963
Visibility from 2 to 4 SM	³	0.808	Frozen Precipitation	-0.103	³
Visibility from 4 to 8 SM	³	-1.500	Gusts	-0.036	³
Xwind from 5 to 12 kt	0.653	0.102	Fog	1.740	³
Xwind from 2 to 5 kt	-0.091	³	Turboprop	-2.517	1.522
Xwind more than 12 kt	2.192	0.706	Foreign Origin/Destination	-0.334	-0.236
Tailwind from 5 to 12 kt	0.066	³	Hub/Non-Hub Airport	³	-0.692
Tailwind more than 12 kt	0.98	³	Log Criticality Factor	4.318	1.707
Temp less than 5°C	0.558	0.988	Night Conditions	-1.360	³

¹LDVO = landing veer-off; TOVO = takeoff veer-off.

²SM = statute miles.

³Blank cells indicate that there are no coefficients associated with these parameters.

Where

Equipment Class	Ref: C	Large jet of MTOW 41k-255k lb (B737, A320 etc.)
Heavy Acft	AB	Heavy jets of MTOW 255k lb+
Commuter Acft	D	Large commuter of MTOW 41k-255k lb (small RJs, ATR42 etc.)
Medium Acft	E	Medium aircraft of MTOW 12.5k-41k lb (biz jets, Embraer 120 Learjet 35 etc.)
Small Acft	F	Small aircraft of MTOW 12.5k or less (small, single or twin engine Beech90, Cessna Caravan etc.)
User Class	Ref: C = Commercial or F = Cargo or T/C = Taxi/Commuter	
User Class G	G = GA	
Turboprop	Turboprop engine(yes/no) – Ref: Turbojet	
Ceiling Height	feet	
Visibility	statute miles	
Crosswind	knots	
Tailwind	knots	
Gusts	Yes/No – Ref: No	
Icing Conditions	Yes/No – Ref: No	
Snow	Yes/No – Ref: No	
Rain	Yes/No – Ref: No	
Frozen Precipitation	Yes/No – Ref: No	
Fog	Yes/No – Ref: No	
Air Temperature	deg C	
Turboprop Aircraft	Yes/No – Ref: No	
NonhubApt	Yes/No – Ref: Yes for hub airport	
Log Criticality Factor	If Log(CF) > 0, available runway distance is smaller than required distance	
Night Conditions	Night, Dawn or Dusk – Ref: Daylight	
Notes:		
	Ref: indicates the reference category against which the odds ratios should be interpreted.	
	Non-hub airport: airport having less than 0.05% of annual passenger boardings	

Table 8. Summary statistics for veer-off frequency models.

Model	R ²	C
LDVO	0.32	0.88
TOVO	0.14	0.82

for each model. Relatively low R² values are the norm in logistic regression (Ash and Schwartz, 1999), and they should not be compared with the R² of linear regressions (Hosmer and Lemeshow, 2000). A better parameter to assess the predictive capability of a logistic model is the C-value. This parameter represents the area under the sensitivity/specificity curve for

the model, which is known as the receiver operating characteristic (ROC) curve.

Sensitivity and specificity are statistical measures of the performance of a binary classification test. Sensitivity measures the proportion of true positives that are correctly identified as such (the percentage of accidents and incidents that are identified when using the model). Specificity measures the proportion of true negatives that are correctly identified (the percentage of normal operations that the model can identify as non-incident). These two measures are closely related to the concepts of Type I and Type II errors. A theoretical, optimal prediction can achieve 100-percent sensitivity (i.e., predict all incidents) and 100-percent specificity (i.e., not predict a normal operation as an incident).

To assess how successful the models are in classifying flights correctly as “incident” or “normal,” and to find the appropriate cut-off points for the logistic regression model, the ROC curves were defined for each model to calculate the *C*-value as shown in Table 8. The values achieved for the veer-off model are considered very good, with the area under the curve representing a *C*-value higher than 80 percent.

The frequency models developed under this study will require the use of historical information on operations and weather for the specific airport. The necessary information on operations includes the time of the flight, runway used, type of aircraft, type of flight, and whether the operation was an arrival or departure. In addition, it is necessary to collect the weather information for the same period that operational data are available, usually for 1 year.

Weather information can be acquired directly from the National Oceanic and Atmospheric Administration (NOAA) database for the weather station located at the airport. However, the information on operations, particularly for non-towered airports, may be harder to obtain, particularly the identification of the runway used. For towered airports operational data can be requested from the FAA. Another challenge is running the analysis because computations can be made only with the help of a computer and specific software that incorporates these models.

To facilitate the analysis, a series of plots were developed based on average veer-off incident rates for the United States. The rates are presented in Table 9 and were combined with the location models to build the risk plots presented in Appendix A. The average incident rates are based on the

number of accidents and incidents, and the total traffic of relevant operations from 1982 to 2009.

From Table 9, one can see that landing veer-offs are approximately four times more likely to occur than takeoff veer-offs.

Event Location

The farthest location of the veer-off path from the runway edge was used to develop the location models. The probability of this distance during an incident is not equal for all locations measured from the runway centerline or runway edge. The probability of veer-off with lateral deviation in the proximity of the runway edge is higher than at larger distances from that boundary. This dependence is represented by the accident location model, which is the second main element of the risk assessment approach. The accident location models are based on historical accident and incident data for aircraft veer-offs.

Worldwide data on accidents and incidents were used to develop the location models. The model structure is an exponential decay function similar to that used in the research reported in *ACRP Report 3* (Hall et al., 2008). Based on the accident/incident location data, two cumulative probability distribution models were developed. With the functions obtained, the fraction of accidents involving locations exceeding a given distance from the runway edge can be estimated. When the probability estimated with the location model is multiplied by the frequency of accident occurrence, it is possible to quantify the overall frequency of incidents involving locations exceeding a given distance from the runway edge.

Figure 19 shows the runway edge origin location used to represent veer-off incidents. The reference location of the aircraft is its nose wheel. The y-axis origin is the edge of the runway, not necessarily the edge of the paved area when the runway has shoulders.

The model structure for the location models is the following:

$$P\{\text{Location} > y\} = e^{-by^m}$$

where

$P\{\text{Location} > y\}$ is the probability that the veer-off distance from the runway edge is greater than y ,

Table 9. Average veer-off incident rates (1982–2009).

Type of Incident	Number of Incidents	Incident Rate per Operation	Incident Rate in Operations per Incident
LDVO	512	1.195E-06	837,000
TOVO	111	2.590E-07	3,861,000

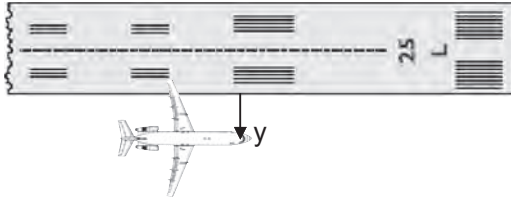

Figure 19. Y origin for aircraft veer-offs.

y is a given location or distance from the runway edge, and b and m are regression coefficients.

A typical transverse location distribution is presented in Figure 20.

The actual model parameters are presented in Table 10 and illustrated in Figures 21 and 22.

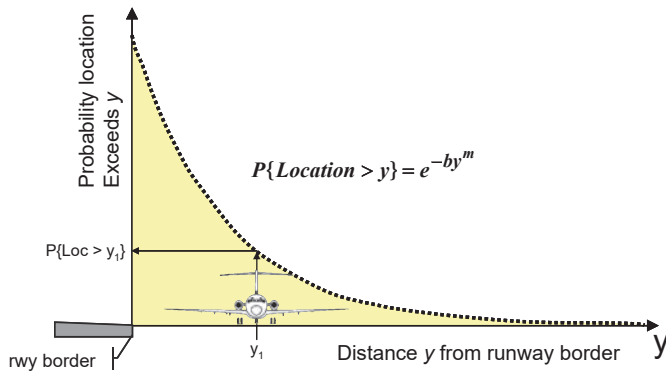

Figure 20. Typical model for aircraft veer-offs.

Table 10. Summary of veer-off location models.

Type of Accident	Type of Data	Model	R ²	# of Points
LDVO	Y	$P\{d > y\} = e^{-0.02568y^{0.803946}}$	99.5%	126
TOVO	Y	$P\{d > y\} = e^{-0.01639y^{0.863461}}$	94.2%	39

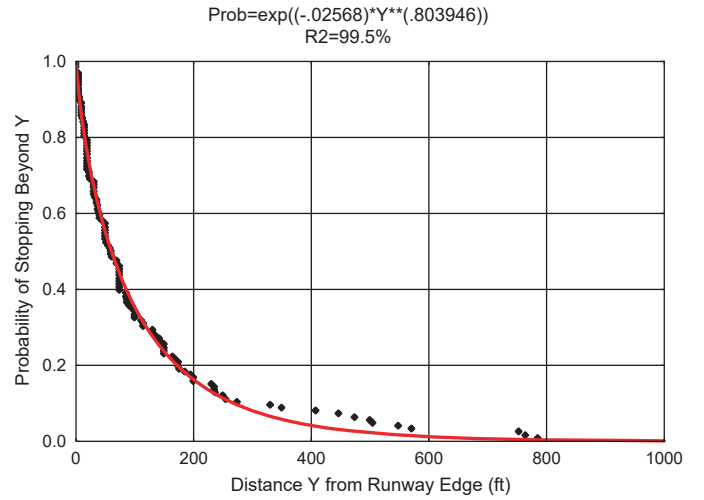

Figure 21. Location model for landing veer-off.

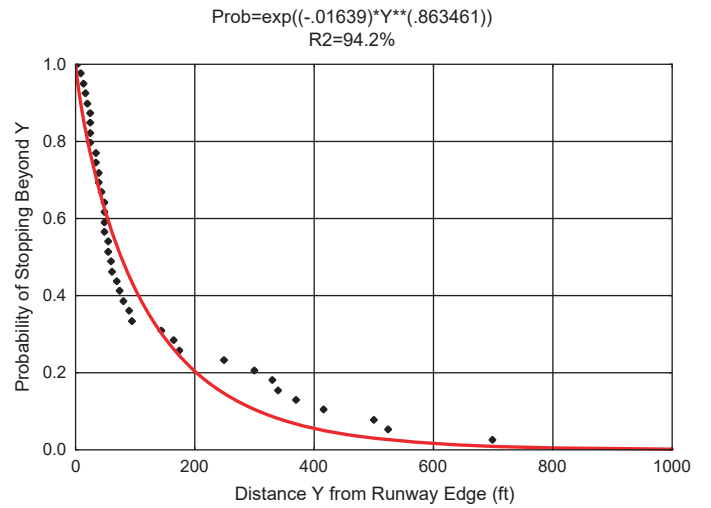

Figure 22. Location model for takeoff veer-off.

CHAPTER 5

Validating the Methodology

MOS Case Studies

One of the goals of this study was to evaluate the types of justification used by airports when submitting MOS requests to the FAA, specifically when the non-compliance issue was related to airfield separation. A second objective was to test and validate the methodology applied to those cases to evaluate how the new methodology might help support such requests. To achieve these objectives, a survey was conducted of airports with MOS for airfield separations that have been approved by the FAA.

MOS Survey

The Airports Division of the FAA regional offices were contacted to obtain a list of airports that have received MOS approvals related to airfield separations. Fifty-nine cases were identified for which some information was available. Out of those cases approved by the FAA, 20 were selected to cover various regions and the spectrum of National Plan of Integrated Airport Systems (NPIAS) categories. The airports were characterized according to geographic region, aircraft operations, fleet mix, airport reference code, and NPIAS classification. The list of MOS cases selected for this study is shown in Table 11. More details about each case are presented in Appendix H.

Methodology Applied to MOS Cases

To validate the methodology and the models developed in this study, the analysis procedures presented in Appendix A were applied to each of the 20 selected MOS cases. A summary of results is presented in Table 12. For each case, the following information is provided:

- The non-standard situation and the compliance standards;
- The analysis of the separation using the risk analysis methodology;

- Comparison of estimated and historical incident/accident rates, when available; and
- Major conclusions on risk level and acceptance.

Additional details for each analysis are presented in Appendix H. The following describes the information contained in each column of Table 12:

- **Airp.**—FAA code of the airport.
- **ADG**—Aircraft Design Group that defines the separation.
- **Type of MOS**—Type of procedure used in the analysis.
- **Risk Level**—Probability for risk severity considered. Catastrophic consequences were considered for every analysis involving runway separation, and major consequences were considered for the remaining cases. The definitions for severity and likelihood classifications are based on the FAA risk matrix (FAA, 2010)
- **Expected # Yrs**—Number of years that an accident is expected to occur.
- **Risk < 1.0E-7**—Yes, if risk is lower than 1 in 10 million operations.
- **Risk < 1.0E-9**—Yes, if risk is lower than 1 in 1 billion operations.
- **Expected Severity**—Worst credible consequence expected for the accident, based on categories defined in the FAA risk matrix (FAA, 2010).
- **FAA Risk Classification**—Level of risk according to classification based on FAA risk matrix (FAA, 2010).
- **Acceptable**—Yes, if level of risk is medium or low; however, for medium risk, measures to mitigate and control may be necessary.

Figures 23 and 24 present a summary of the most frequent justifications and restrictions, respectively, when submitting MOS requests related to airfield separations.

As observed in Table 12, the methodology would help support the analysis of MOS. With the exception of one case,

Table 11. Airports included in the MOS survey.

ase #	Airport	ID	NPIA ¹	MO Type ²	FAA Re ion
1	Philadelphia, PA	PHL	LH	TWY/TWY	AEA
2	Anchorage, A	ANC	MH	TWY/OBJ	AAL
3	Addison, TX	ADS	RL	RWY/TWY	ASW
4	Bridgeport, CT	BDR	GA	RWY/TWY	ANE
5	Accomack, VA	MFV	GA	RWY/OBJ	AEA
6	Lincoln Park, NJ	N07	RL	TLN/OBJ	AEA
7	New York JF , NY	JF	LH	TWY/TWY	AEA
8	Newark, NJ	EWR	LH	TWY/TWY	AEA
9	Minneapolis, MN	MSP	LH	TWY/TWY	AGL
10	Chicago, IL	ORD	LH	TWY/TWY	AGL
11	Chicago, IL	ORD	LH	TWY/OBJ	AGL
12	Barnstable, MA	HYA	NH	RWY/TWY	ANE
13	Laconia, NH	LCI	GA	RWY/TWY	ANE
14	Seattle-Tacoma, WA	SEA	LH	RWY/TWY	ANM
15	Seattle-Tacoma, WA	SEA	LH	TWY/TWY	ANM
16	Aspen, CO	ASE	NH	RWY/OBJ	ANM
17	Nantucket, MA	AC	NH	TWY/TWY	ANE
18	New Castle, DE	ILG	GA	TWY/TWY	AEA
19	Leesburg, VA	JYO	RL	RWY/OBJ	AEA
20	Taunton, MA	TAN	GA	RWY/TWY	ANE

¹National Plan of Integrated Airport Systems (NPIAS) Classification

LH: Primary, Large Hub
 MH: Primary, Medium Hub
 SH: Primary, Small Hub
 NH: Primary, Non-Hub
 RL: Reliever
 GA: General Aviation

²MOS Type

RWY/TWY: runway to taxiway separation
 TWY/TWY: taxiway to taxiway separation
 TWY/TLN: taxiway to taxilane separation
 TWY/OBJ: taxiway to object separation
 TLN/TLN: taxilane to taxilane separation
 TLN/OBJ: taxilane to object separation
 RWY/OBJ: runway to object separation

³FAA Regions with Relevant MOS Cases

AEA: Eastern
 AAL: Alaska
 ASW: Southwest
 ANE: New England
 AGL: Great Lakes
 ANM: Northwest Mountain

the analysis results provided an insight into the quantitative risk associated with each case. Moreover, the results helped identify the level of risk and consequently the need to include additional measures to control risk.

The cases with low levels of risk are satisfactory without additional measures, except to keep the conspicuity of taxiway and taxilane centerlines under any weather conditions.

Based on these results, some important conclusions can be drawn:

- The suggested level of risk criterion for taxiway/taxilane/object separations is one accident in 10 million movements. This criterion was met for each of the case studies that does not involve runway separations. This is also the maximum risk for the range defined in the FAA risk matrix for accidents of major severity, the worst

credible consequence for taxiway/taxilane collisions (FAA, 2010).

- The same criterion is suggested to evaluate runway separations because it was the basis for defining design standards using the FAA/ICAO CRM. It should be noted that the most credible consequence for aircraft veering off a runway is catastrophic. As such, the acceptable risk level is one accident in 1 billion operations, and according to the FAA, the risk is classified as medium.
- The FAA also added criteria specific for airports, and the maximum risk for accidents of major consequences is one in every 2.5 million departures or 4×10^{-7} ; however, based on the results of the analysis using the risk methodology, a more conservative level may be used, and a level of one accident in 10 million operations for cases involving taxiway/taxilane/object is recommended.

Table 12. Summary of results for MOS case studies.

Airp	ADG	Type of MO	Ris Le el	pected # rs	Ris 1	Ris 1	pected e erity	FAA Ris lassification	Acceptable
PHL	III IV	Taxilane/Taxilane	1.0E-9	N/A	Yes	Yes	Major	Low	Yes
ANC	VI	Taxiway/Object	1.0E-9	N/A	Yes	Yes	Major	Low	Yes
ADS	III	Runway/Taxiway	1.0E-7	> 100	Yes	No	Catastrophic	Medium	Yes
BDR	II	Runway/Taxiway	1.1E-7	> 100	No	No	Catastrophic	Medium	Yes
MFV	II	Runway/Object	5.9E-8	> 100	Yes	No	Catastrophic	Medium	Yes
N07	I	Taxilane/Object	1.2E-9	N/A	Yes	No	Major	Low	Yes
JF	VI	Taxiway/Taxiway	1.0E-9	N/A	Yes	Yes	Major	Low	Yes
EWR	V	Taxiway/Taxiway	1.0E-9	N/A	Yes	Yes	Major	Low	Yes
		Taxilane/Object	1.0E-9	N/A	Yes	Yes	Major	Low	Yes
MSP	IV	Taxiway/Taxiway	1.0E-9	N/A	Yes	Yes	Major	Low	Yes
ORD	V	Taxiway/Object	1.0E-9	N/A	Yes	Yes	Major	Low	Yes
ORD	V	Taxiway/Taxiway	1.0E-9	N/A	Yes	Yes	Major	Low	Yes
HYA	III	Runway/Taxiway	8.8E-8	> 100	Yes	No	Catastrophic	Medium	Yes
LCI	III	Runway/Taxiway	2.0E-7	> 100	No	No	Catastrophic	Medium	Yes
SEA	VI	Runway/Taxiway	1.6E-6	N/A	No	No	Catastrophic	High ¹	No ¹
SEA	VI	Taxiway/Taxilane	1.0E-9	N/A	Yes	Yes	Major	Low	Yes
ASE	III	Runway/Taxiway	9.0E-8	> 100	Yes	No	Catastrophic	Medium	Yes
AC	III	Taxiway/Taxiway	1.0E-9	N/A	Yes	Yes	Major	Low	Yes
ILG	IV	Taxiway/Object	2.8E-8	N/A	Yes	No	Major	Low	Yes
JYO	II	Runway/Taxiway	1.2E-7	> 100	No	No	Catastrophic	Medium	Yes
TAN	II	Runway/Taxiway	8.0E-8	> 100	Yes	No	Catastrophic	Medium	Yes

¹MOS approval conditions by the FAA restrict the use of the taxiway under specific conditions to avoid the situation of high risk.

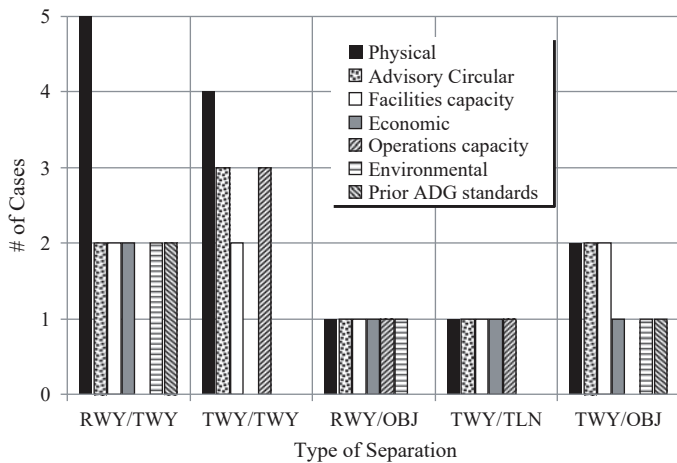

Figure 23. Most common justifications for MOS of airfield separations.

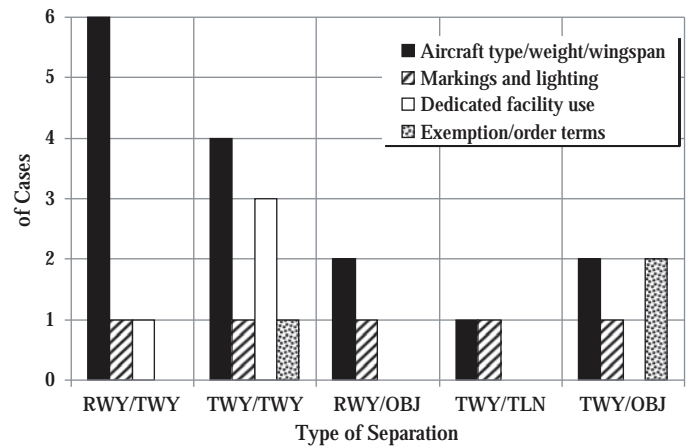

Figure 24. Most common restrictions for MOS of airfield separations.

CHAPTER 6

Conclusions and Recommendations

The aviation industry is relatively young compared to other industries. Over the past 100 years, rapid technological changes have had a substantial impact on airfield configuration and design standards. Airfield standards have been modified to improve safety and to accommodate new technology to improve airport capacity and maintain acceptable safety levels. When the standards are changed to require larger areas and dimensions, existing airports increasingly find themselves constrained by land development and other natural features.

Another common situation occurring with airports is the need to have larger aircraft operating at the airport to increase capacity. In this case, the new aircraft may belong to a higher ADG, and the corresponding standards may be different and require larger airfield separations.

The methodology developed in this study provides a practical and simple tool to help airports quantify and evaluate risk if they cannot comply with the standards and want to pursue an MOS to submit to the FAA. The methodology is based on lateral deviation studies and models developed in this research as well as in previous studies conducted by the FAA, Boeing, and ICAO. A comprehensive survey of accidents and incidents associated with lateral deviations during landing, takeoff, and taxiing operations was conducted to identify causal and contributing factors, as well as to characterize the lateral deviation during those events.

Major Achievements

Airfield Separation Rationale to Develop Standards

It is simple to understand the need for airfield separations to avoid aircraft collisions. However, the rationale used by the FAA and ICAO to establish existing standards is not readily available in the literature. This study gathered the information available from FAA and ICAO personnel who were involved

in the development or in the management of those standards. The information presented in Chapter 2 herein can be very helpful to the industry and provides documentation that may be used for reference in future studies.

Development of Veer-off Accidents and Incidents Database

A comprehensive worldwide database of aircraft veer-off accidents and incidents was developed that contains information gathered from existing accident and incident databases and information obtained from other sources (e.g., weather data). The database was developed in Microsoft Access, which provides editing and querying capabilities. The database contains a synopsis of the event, date, location, runway characteristics, characteristics of the aircraft involved, causal factors, consequences, and wreckage location/path data.

Development of Risk Models for Runway Veer-Offs

Risk models for aircraft veer-off during takeoff and landing operations were developed using an approach similar to that presented in *ACRP Report 3* for overruns and undershoots (Hall et al., 2008). A two-part model based on the probability of an incident occurring and an estimate of the probability that the aircraft will travel beyond a given distance from the runway edge is used to assess the risk that an aircraft may depart the existing safety areas.

The frequency model is based on operational and weather factors, including a criticality factor that related aircraft performance under given conditions with the available distance for operation. The frequency model uses accident, incident, and normal operations data to quantify accident risk factors and provide an assessment of flight risk exposure.

Development of a Tool to Analyze Airfield Separations

An analysis process for each type of airfield separation is presented in Appendix A. The procedures are simple to use, and the instructions include practical examples to help the user.

The methodology serves as a screening tool to support MOS requests involving airfield separations when the standards cannot be met. The process helps to quantify the risk levels for non-standard conditions and, based on criteria recommended in this report, in agreement with the FAA risk matrix, it is possible to evaluate the feasibility of approval of an MOS request (FAA, 2010).

Different procedures are provided depending on the type of airfield separation. It is possible to analyze separations involving runways, taxiways, taxilanes, and objects. A specific approach was used for each type of separation. To facilitate the application of the methodology, risk plots are presented for each ADG, and when the analysis involves specific aircraft, risk plots based on wingtip clearance are provided.

Recommended Risk Criteria for Taxiway and Taxilane Separations

An extensive survey of historical taxiway and taxilane incidents helped assess the major factors involved in these events. Due to the slow speeds of aircraft on taxiways and taxilanes as compared to aircraft speeds on runway operations, even under adverse weather conditions or slippery pavements, the pilot was able to stop the aircraft as soon as it departed the paved surface of the taxiway. Further, historical taxiway collision events were not related to taxiway deviations. In almost every accident/incident, the collision occurred because there was another aircraft or movable object inside the OFA of the taxiing aircraft.

One major conclusion is that the existing standards provide an excellent level of safety and that the risk is lower than one accident in 1 billion operations. Even when another aircraft or object was in the path, resulting in a collision, there has never been a serious injury associated with the accidents, and the damages have been limited mostly to the wingtip of the aircraft.

Based on the available evidence, the worst credible consequence for a taxiway or taxilane according to the FAA risk matrix is major damage to aircraft and/or minor injury to passengers/workers, major unplanned disruption to airport operations, or serious incident (FAA, 2010). For major consequences, the maximum acceptable level of likelihood is “remote.” In this case, a remote event is expected to occur once every year or 2.5 million departures, whichever occurs sooner.

Limitations

The methodology developed in this study has some limitations. Risk of collision between two aircraft, or an aircraft and an object, estimated with this methodology is applicable only to straight parallel segments of taxiways and taxilanes.

Although the lateral deviation data in taxiing operations used to develop the risk plots were measured only for the B-747 aircraft, it is assumed that smaller aircraft have lateral deviation distributions that have smaller ranges. Thus, the model can be considered conservative when applied to smaller aircraft. However, the taxiway deviation models used in this study were developed from lateral deviation data collected on taxiways with centerline lights. Therefore, the conspicuity of the taxiway/taxilane centerline is an added risk mitigation measure that should be used when justifying an MOS request.

The FAA/ICAO CRM during missed approach was developed based on data for two- and three-engine jet airplanes. The veer-off models developed under this study are based on data from veer-off accident/incident reports taken from several countries and for aircraft with MTOW larger than 5,600 lb.

The collision risk during the approach phase of landing is modeled for missed approach during instrument approaches under Cat I and II. This is assumed to be the highest risk condition, and the phase when the pilot is under visual conditions is not modeled in the risk curves presented.

CRM risk is estimated for an aircraft located on the centerline of a parallel taxiway. The taxiing aircraft is of the same ADG as the approaching aircraft, and the maximum tail height for the ADG is taken to characterize the obstacle located in the taxiway. The same plots may be used to assess risks associated with other types of obstacles at a certain distance from the runway centerline; however, such obstacles must be lower than the maximum tail height of the ADG used to develop the charts.

Recommendations for Future Work

Effort to Collect Taxiway/Taxilane Deviation Data

As described in previous sections of this report, many of the separation standards were developed during World War II and were based on engineering judgment. These standards have helped maintain very high levels of safety, as evidenced by the fact that there is no history of collisions between two aircraft taxiing in parallel routes.

With the increase in traffic volume and the need to increase airport capacity, many airports are restricted in their ability to increase existing airfield separations to introduce operation of larger aircraft. Although the FAA permits MOS based on formulas developed for this purpose, the formulas were developed based on engineering judgment, rather than using a probability approach.

Recent FAA studies on aircraft deviation for large aircraft have demonstrated the feasibility of collecting data to develop risk models. However, these studies have focused on large aircraft on taxiway segments with centerline lights. There is a need to collect additional data for various categories of aircraft, for both taxiway and taxilane segments, under various environmental conditions, with and without conspicuous centerline markings, and with and without centerline lights.

Such studies should not be undertaken to modify the current standards, but they can support MOS processes when the evaluation of shorter-than-standard distances is necessary.

Effort to Collect Aircraft Deviation Data during Landing and Takeoff Operations

The development of risk plots for the airborne phase of landing used the FAA/ICAO CRM for instrument approach

Cat I and II. The CRM model was based on the limited data available at the time it was developed. Aircraft technology and navigational aids have improved significantly since then. As it is expected that airport capacity will need to increase two- or threefold in the near future, it is necessary to develop a more rational approach to more accurately assess the level of safety. Many airports still rely on visual and non-precision approaches, and for these categories, that analysis can be made only by using Part 77 imaginary surfaces obstruction evaluation to obtain a very basic assessment of risk.

A risk-based model for the assessment of visual segment or non-precision approaches would benefit many airports in the United States and abroad, particularly for the evaluation of airfield areas. Therefore, studies that address risk assessment for aircraft operations associated with movable or fixed objects within or in the vicinity of airports would greatly benefit the aviation industry.

Glossary of Acronyms

AAIB	UK Air Accidents Investigation Branch
AAIU	Ireland Air Accident Investigation Unit
AC	Advisory Circular
ADG	Aircraft Design Group
AIDS	FAA Accident/Incident Data System
ANC	Ted Stevens Anchorage International Airport
AOSC	Airport Obstructions Standards Committee
ARC	Airport Reference Code
ARCP	Aerodrome Reference Code Panel
ASPM	Aviation System Performance Metrics
ASRS	FAA/NASA Aviation Safety Reporting System
ATSB	Australian Transport Safety Bureau
BEA	Bureau d'Enquêtes et d'Analyses pour la Sécurité de l'Aviation Civile
CAA	Civil Aeronautics Administration
CG	Center of Gravity
CIAIAC	Comisión de Investigación de Accidentes e Incidentes de Aviación Civil (Spain)
CRM	Collision Risk Model
ETMSC	Enhanced Traffic Management System Counts
FAAP	Federal Aid Airport Program
FAR	Federal Aviation Regulation
FHA	Functional Hazard Analysis
GA	General Aviation
ICAO	International Civil Aviation Organization
IFALPA	International Federation of Airline Pilots' Associations
ILS	Instrument Landing System
ISO	International Organization for Standardization
JFK	John F. Kennedy International Airport
LDVO	Landing Veer-off
MOS	Modification of Standards
MTOW	Maximum Takeoff Weight
NAS	National Airspace System
NASA	National Aeronautics and Space Administration

NASB	Netherlands Aviation Safety Board
NLA	New Large Aircraft
NOAA	National Oceanic and Atmospheric Administration
NOD	Normal Operations Data
NPIAS	National Plan of Integrated Airport Systems
NTSC	National Transportation Safety Committee (Indonesia)
OCH	Obstacle Clearance Height
OCP	Obstacle Clearance Panel
OFA	Object Free Area
OFZ	Obstacle Free Zone
RESA	Runway End Safety Area
ROC	Receiver Operating Characteristic
RSA	Runway Safety Area
SARP	Standard and Recommended Practice
TAIC	New Zealand Transport Accident Investigation Commission
TERP	Terminal Instrument Procedures
TOVO	Takeoff Veer-Off
TSB	Transportation Safety Board of Canada
USACE	United States Army Corps of Engineers

Definitions

Acceptable Level of Risk. For regulations and special permits, the acceptable levels of risk are established by consideration of risk, cost/benefit, and public perception.

Accident. An unplanned event or series of events that results in death, injury, damage to, or loss of, equipment or property.

Consequence. The direct effect of an event, incident, or accident. In this study, it is expressed as a health effect (e.g., death, injury, exposure) or property loss.

Hazard. The inherent characteristic of a material, condition, or activity that has the potential to cause harm to people, property, or the environment.

Hazard Analysis. The identification of system elements, events, or material properties that lead to harm or loss. The term “hazard analysis” may also include evaluation of consequences from an event or incident.

Incident. A near-miss episode, malfunction, or failure without accident-level consequences that has a significant chance of resulting in accident-level consequences.

Likelihood. Expressed as either a frequency or a probability. Frequency is a measure of the rate at which events occur over time (e.g., events/year, incidents/year, deaths/year). Probability is a measure of the rate of a possible event expressed as a fraction of the total number of events (e.g., 1 in 10 million, 1/10,000,000, or 1×10^{-7}).

METAR. Aviation routine weather report.

Nonconformity. Non-fulfillment of a requirement. This includes, but is not limited to, non-compliance with federal regulations. It also includes an organization’s requirements, policies, and procedures, as well as requirements of safety risk controls developed by the organization.

Quantitative Risk Analysis. Incorporates numerical estimates of frequency or probability and consequence.

Risk. The combination of the likelihood and the consequence of a specified hazard being realized. It is a measure of harm or loss associated with an activity.

Risk Analysis. The study of risk in order to understand and quantify risk so it can be managed.

Risk Assessment. Determination of risk context and acceptability, often by comparison to similar risks.

Safety. Freedom from unacceptable risk. Often, safety is equated with meeting a measurable goal, such as an accident rate that is less than an acceptable target. However, the absence of accidents does not ensure a safe system. To remain vigilant regarding safety, it is necessary to recognize that just because an accident has not happened does not mean that it cannot or will not happen.

Safety Risk Management. The systematic application of policies, practices, and resources to the assessment and control of risk affecting human health and safety and the environment. Hazard, risk, and cost/benefit analysis are used to support the development of risk reduction options, program objectives, and prioritization of issues and resources. A critical role of the safety regulator is to identify activities involving significant risk and to establish an acceptable level of risk.

Veer-Off. An aircraft running off the side of the runway during takeoff or landing roll.

Worst Credible Condition. The most unfavorable condition or combination of conditions that it is reasonable to expect will occur.

References

- AOSC (Airport Obstructions Standards Committee). 2005. *AOSC Decision Document #04—Runway/Parallel Taxiway Separation Standards*. Washington, DC: FAA, U.S. DOT.
- Ash, A., and M. Schwartz. 1999. “R2: A Useful Measure of Model Performance When Predicting a Dichotomous Outcome.” *Statistics in Medicine*, 18(4), 375–384.
- ATSB (Australian Transport Safety Bureau). 2009. *ATSB Transport Safety Report: Aviation Research and Analysis AR-2008-018(1) Final—Runway Excursions—Part 1: A Worldwide Review of Commercial Jet Aircraft Runway Excursions*. Australia.
- Boeing. July 2009. *Statistical Summary of Commercial Jet Airplane Accidents—Worldwide Operations 1959–2008*.
- Brown, D. N., and O. O. Thompson. July 1973. “Lateral Distribution of Aircraft Traffic,” Miscellaneous Paper S-73-56. Vicksburg, MS: U.S. Army Engineer Waterways Experiment Station Soils and Pavements Laboratory.
- Civil Aeronautics Authority. 1940. *Airport Design Information*. Technical Development Division—Airport Section, Washington, DC.
- Cohen-Nir, D., and R. Marchi. 2003. “Preliminary Analysis of Taxiway Deviation Data and Estimates of Airplane Wingtip Collision Probability.” *Transportation Research Record: Journal of the Transportation Research Board*, No. 1850, 49–60.
- David, R. 1973. “Landing Strip/Runway Safety Area Dimensional Criteria.” Paper presented at Design Standards Meeting (FAA internal meeting), Dallas, TX, Oct 4, 1973.
- Eddowes, M., J. Hancox, and A. MacInnes. December 2001. *Final Report on the Risk Analysis in Support of Aerodrome Design Rules—AEAT/RAIR/RD02325/R/002 Issue 1* (produced for the Norwegian Civil Aviation Authority). Cheshire, UK: AEA Technology.
- FAA. 1959. *Airport Design Recommendations*, Airport Engineering Data Sheet No. 24, Washington, DC.
- FAA. 1963. *VFR Airports*, AC 150/5300-1, Washington, DC.
- FAA. 1968. *Utility Airports*, AC 150/5300-4A, Washington, DC.
- FAA. 1983. *Airport Design Standards—Transport Airports*, AC 150/5300-12. Washington, DC.
- FAA. 1989. *Advisory Circular (AC) 150/5300-13, Airport Design (with changes)*. Washington, DC.
- FAA. 2008. “Missed Approach Rates” (DOT-FAA-AFS-450-48). Oklahoma City, OK: Flight Systems Laboratory.
- FAA. 2010. *FAA Order 5200.11 (FAA Airports [ARP] Safety Management System)*.
- Federal Aviation Agency. 1961. *Airport Design*, Airport Engineering Branch, Airports Division, Bureau of Facilities and Materiel, Washington, DC.
- Flight Safety Foundation (FSF). 2000. *ALAR Tool Kit*, Briefing Note 8.3—Landing Distances, Flight Safety Digest.
- Flight Safety Foundation. 2009. “Reducing the Risk of Runway Excursions,” Report of the Runway Safety Initiative.
- Hall, J., M. Ayres Jr., D. Wong, A. Appleyard, M. Eddowes, H. Shirazi, R. Speir, D. Pitfield, O. Selezneva, and T. Puzin. 2008. *ACRP Report 3: Analysis of Aircraft Overruns and Undershoots for Runway Safety Areas*. Washington, DC: Transportation Research Board of the National Academies.
- Hathi Trust Digital Library. <http://catalog.hathitrust.org/Record/005745193>.
- HoSang, V. A. February 1975. *Field Survey and Analysis of Aircraft Distribution on Airport Pavements* (FAA-RD-74-36). Washington, DC: FAA, U.S. DOT.
- Hosmer, D., and S. Lemeshow. 2000. *Applied Logistic Regression*. Hoboken, NJ: Wiley & Sons.
- ICAO. 1949. “Aerodromes.” Annex 14 to the Chicago Convention, 1st ed.
- ICAO. 1980. “Doc 9274—Manual on the Use of the Collision Risk Model (CRM) for ILS Operations,” 1st ed.
- ICAO. November 1981. “Aerodromes.” Annex 14 to the Chicago Convention, 1st ed., Amendment 35.
- ICAO. 1990. “Aerodromes, Aerodrome Design and Operations.” International Standards and Recommended Practices, Annex 14, Volume I, 2nd ed.
- ICAO. 2004. “Aerodromes, Aerodrome Design and Operations.” International Standards and Recommended Practices, Annex 14, Volume I, 4th ed.
- ICAO. 2006a. “Aerodrome Design Manual.” Doc 9157-AN/901, Part 1: Runways, 3rd ed.
- ICAO. 2006b. “Aerodromes, Aerodrome Design and Operations.” International Standards and Recommended Practices, Annex 14, Volume I, 5th ed.
- IFALPA (International Federation of Airline Pilots’ Associations). Accessed 2008. *IFALPA Runway Safety Policy* (09POS01). Available from www.ifalpa.org/positionstatements/09POS01_Runway_Safety.pdf.
- NTSB. 2009. *Annual Review of Aircraft Accident Data—U.S. Air Carrier Operations: Calendar Year 2005* (NTSB/ARC-09/01, PB2009-106372, Notation 7502F). Washington, DC.

Scholz, F. 2003a. *Statistical Extreme Value Analysis of ANC Taxiway Centerline Deviations for 747 Aircraft* (prepared under a cooperative research and development agreement between the FAA and Boeing).

Scholz, F. 2003b. *Statistical Extreme Value Analysis of JFK Taxiway Centerline Deviations for 747 Aircraft* (prepared under a coopera-

tive research and development agreement between the FAA and Boeing).

Scholz, F. 2005. *Statistical Extreme Value Analysis Concerning Risk of Wingtip to Wingtip or Fixed Object Collision for Taxiing Large Aircraft* (prepared under a cooperative research and development agreement between the FAA and Boeing).

APPENDIX A

Risk Assessment Methodology

CONTENTS

How to Use This Methodology,	A-2
Limitations,	A-2
Risk Criteria,	A-3
Section 1 Taxiway to Taxiway or Taxiway to Taxilane,	A-5
Section 2 Taxiway to Object,	A-5
Section 3 Taxilane to Taxilane,	A-7
Section 4 Taxilane to Object,	A-8
Section 5 Runway to Taxiway, Taxilane, or Object,	A-8
Attachment—Risk Plots,	A-13

How to Use This Methodology

This methodology is intended to serve as a screening tool for analysis associated with requests for modification of standards (MOS) related to airfield separations. In no case should this methodology be used to justify changes to current FAA design standards for airfields. Conclusions drawn based on this methodology shall be subject to further analysis and approval by the FAA before the non-standard separation is adopted. Additional mitigating procedures and risk control measures may be required to achieve an acceptable level of safety for operations in the airfield.

This appendix provides a step-by-step methodology to evaluate the risk of aircraft collision associated with airfield separations in parallel segments. The methodology uses information on existing or planned conditions and provides estimates of risk. The level of risk should be compared to acceptable levels of risk recommended by the FAA.

Different procedures are used depending on the type of analysis desired, as explained in ensuing sections. The methodology is divided into five basic sections, and each section presents the procedure to assess the risk for a specific scenario.

The outcome of the analysis is the risk of collision between two aircraft or between an aircraft and an object, depending on the type of analysis required. To determine the appropriate section containing the methodology and step-by-step procedure for the desired type of analysis, the two types of structures must be selected from Table A-1. For example, to analyze the separation between a taxiway and an object, the user should use the procedure described in Section 2 and the risk plots presented in Figures AA-8 to AA-14 presented in the attachment to Appendix A.

When describing the procedure, some acronyms are used to characterize specific parameters. Definitions of these acronyms can be found within the section in which they appear. When an equation is included in the procedure, a number located in parenthesis to the right of it is used to reference the equation in the text.

Many of the risk plots presented in this methodology should be used for specific Aircraft Design Groups (ADGs) as defined in FAA Advisory Circular (AC) 150/5300-13 (FAA, 1989).

Table A-2. Airplane Design Groups (FAA, 1989).

Group #	Tail height ft	Wingspan ft
I	20	49
II	20 to 30	49 to 79
III	30 to 45	79 to 118
IV	45 to 60	118 to 171
V	60 to 66	171 to 214
VI	66 to 80	214 to 262

Table A-2 presents a summary of tail height and wingspan ranges for each ADG.

As mentioned earlier, the outcome of the analysis is the risk of collision. Both the FAA and the International Civil Aviation Organization (ICAO) have been using a collision risk value of one in 10 million operations (1×10^{-7}) as the acceptable level during the approach phase under instrument conditions. This is also the level criterion suggested when applying this methodology.

Limitations

This methodology should be used carefully, and the user must be aware of its limitations. This methodology can be applied to estimate the risk of collision between two aircraft or an aircraft and an object only on straight parallel segments of taxiways and taxilanes. Also, because the taxiway deviation models used in this study were developed from lateral deviation data collected on taxiways with centerline lights, the conspicuity of the taxiway/taxilane centerline is an added risk mitigation measure that should be used when justifying an MOS request for separations that do not include runways.

Although lateral deviation data in taxiing operations used to develop the risk plots were measured only for the B-747 aircraft, it is assumed that smaller aircraft have lateral deviation distributions that have smaller ranges. Thus, the model applied can be considered conservative when applied to smaller aircraft.

The FAA/ICAO Collision Risk Model (CRM) during missed approach was developed based on data for two- and three-engine jet airplanes. The veer-off models developed under this

Table A-1. Procedure selection.

	Taxiway	Taxilane	Runway
Taxiway	Section 1 (Figures AA-1 to AA-7)	Section 1 (Figures AA-1 to AA-7)	Section 5 (Figures AA-29 to AA-54)
Taxilane	Section 1 (Figures AA-1 to AA-7)	Section 3 (Figures AA-15 to AA-21)	Section 5 (Figures AA-29 to AA-54)
Object	Section 2 (Figures AA-8 to AA-14)	Section 4 (Figures AA-22 to AA-28)	Section 5 (Figures AA-29 to AA-54)

ACRP study are based on data from veer-off accident/incident reports taken from several countries and for aircraft with maximum takeoff weight (MTOW) larger than 5,600 lb.

The collision risk during the approach phase of landing is modeled for missed approach during instrument approaches under Cat I and II. This is assumed to be the highest risk condition, and the phase when the pilot is under visual conditions is not modeled in the risk curves presented.

CRM risk is estimated for an aircraft located on the centerline of a parallel taxiway. The taxiing aircraft is of the same ADG as the approaching aircraft, and the maximum tail height for the ADG is taken to characterize the obstacle located in the taxiway. The same plots may be used to assess risks associated with other types of obstacles at a certain distance from the runway centerline; however, such obstacles must be lower than the maximum tail height of the ADG used to develop the charts.

Risk Criteria

The suggested risk criteria to use with this methodology are those used by the FAA and represented by the risk matrix shown in Figure A-1 (FAA, 2010). A risk classification (high, medium, or low) is provided based on the combination of severity and likelihood.

Severity is the measure of how bad the results of an event are predicted to be and is defined as the worst credible consequence that may take place for risk associated with a given hazard. Likelihood should be considered only after determin-

ing severity, and at the same time, likelihood should not be considered when determining severity.

Definitions for each level of severity and consequence are presented in Tables A-3 and A-4.

Two cases can serve as examples: (1) risk of collision between an aircraft landing and an aircraft located in a parallel taxiway and (2) risk of wingtip collision between aircraft taxiing in parallel taxiways. The first step is to determine the worst credible consequence for each of these events. The worst credible consequence for runway veer-offs in most cases is hull loss and multiple fatalities, which is classified as catastrophic. According to the FAA risk matrix, such a condition is acceptable only if it occurs less than once every 100 years or less than once in 25,000,000 departures.

For the second case, based on historical data of accidents and incidents, the worst credible consequence may be classified as major. In this case, the risk is acceptable if it is expected to occur about once every year or every 2.5 million departures (4×10^{-7}), whichever occurs sooner.

The ICAO Obstacle Clearance Panel (OCP) has set the acceptable risk of collision during the approach phase at a value of one in 10 million operations (1×10^{-7}). Since this is the risk level used to establish most of the airfield design standards defined by the FAA, and this methodology will serve as a screening tool, this criterion is used in this screening methodology. However, the risk classification based on the risk matrix defined by the FAA must be highlighted when submitting MOS for FAA approval (FAA, 2010).

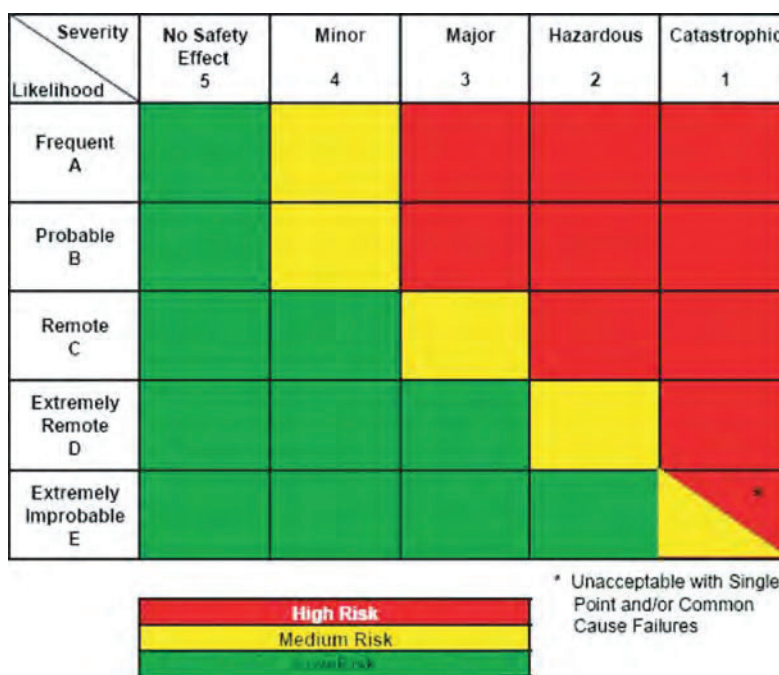

Figure A-1. FAA risk matrix (FAA, 2010).

Table A-3. FAA likelihood levels (FAA, 2010).

	General	Airport specific	AT Operational	
			Per Facility	NA ide
Fre uent A	Probability of occurrence per operation is equal to or greater than $1 \cdot 10^{-3}$	Expected to occur more than once per week or every 2,500 departures ($4 \cdot 10^{-4}$), whichever occurs sooner	Expected to occur more than once per week	Expected to occur every 1–2 days
Probable	Probability of occurrence per operation is less than $1 \cdot 10^{-3}$, but equal to or greater than $1 \cdot 10^{-5}$	Expected to occur about once every month or 250,000 departures ($4 \cdot 10^{-6}$), whichever occurs sooner	Expected to occur about once every month	Expected to occur several times per month
Remote	Probability of occurrence per operation is less than $1 \cdot 10^{-5}$ but equal to or greater than $1 \cdot 10^{-7}$	Expected to occur about once every year or 2.5 million departures ($4 \cdot 10^{-7}$), whichever occurs sooner	Expected to occur about once every 1–10 years	Expected to occur about once every few months
tremely Remote D	Probability of occurrence per operation is less than $1 \cdot 10^{-7}$ but equal to or greater than $1 \cdot 10^{-9}$	Expected to occur once every 10–100 years or 25 million departures ($4 \cdot 10^{-8}$), whichever occurs sooner	Expected to occur about once every 10–100 years	Expected to occur about once every 3 years
tremely Improbable	Probability of occurrence per operation is less than $1 \cdot 10^{-9}$	Expected to occur less than once every 100 years	Expected to occur less than once every 100 years	Expected to occur less than once every 30 years

Note: Occurrence is defined per movement.

Table A-4. FAA severity definitions (FAA, 2010).

a a r d e rity lassification				
Minimal	Minor	Major	a a r dous 2	atastrop ic 1
No damage to aircraft but minimal injury or discomfort of little consequence to passenger(s) or workers	- Minimal damage to aircraft; - Minor injury to passengers; - Minimal unplanned airport operations limitations (i.e. taxiway closure); - Minor incident involving the use of airport emergency procedures	- Major damage to aircraft and/or minor injury to passenger(s)/ worker(s); - Major unplanned disruption to airport operations; - Serious incident; - Deduction on the airport's ability to deal with adverse conditions	- Severe damage to aircraft and/or serious injury to passenger(s)/ worker(s); - Complete unplanned airport closure; - Major unplanned operations limitations (i.e. runway closure); - Major airport damage to equipment and facilities	- Complete loss of aircraft and/or facilities or fatal injury in passenger(s)/ worker(s); - Complete unplanned airport closure and destruction of critical facilities; - Airport facilities and equipment destroyed



Figure A-2. Example of taxiway/taxiway separation analysis for specific aircraft.

Section 1—Taxiway to Taxiway or Taxiway to Taxilane

Procedure to Estimate Risk of Collision

1. Identify the taxiways and the centerline separation to be evaluated.
2. Identify the ADG for analysis or the aircraft with the largest wingspan that will be using each taxiway. It is possible that each taxiway is assigned to a different ADG or specific aircraft.
3. If the assessment is for a specific ADG, the simplified collision risk plots can be used based only on the taxiway centerline separation (Figures AA-1 to AA-6 in the attachment to this appendix).
4. If the risk assessment involves specific aircraft or two different types of aircraft, the wingtip separation chart in Figure AA-7 should be used, and in this case, the following steps will be required:
 - a. Place both aircraft at the centerlines of the parallel taxiways (see Figure A-2).
 - b. Calculate the wingtip clearance for this situation using Equation 1:

$$WD = CS - (WS1 + WS2) / 2 \quad (1)$$

where

WD is the distance between wingtips of the two aircraft when both are positioned at the centerline of the taxiways,

CS is the centerline separation between the parallel taxiways,

WS1 is the wingspan for the first aircraft, and *WS2* is the wingspan for the second aircraft.

- c. Using Figure AA-7, enter the wingtip separation and estimate the risk.
5. Using the risk level estimated, compare to 1×10^{-7} , the upper probability for risk of major consequences according to the risk matrix recommended by the FAA.

Example 1—Taxiway/Taxiway Separation

An airport is planning to build a new taxiway to accommodate larger capacity. The airport handles aircraft up to ADG V; however, the space available is enough for a taxiway/taxiway centerline separation of only 233 ft, as shown in Figure A-3. The standard separation for ADG V is 267 ft, and an MOS was deemed necessary to demonstrate that the available separation is safe.

For taxiway/taxiway separation involving ADG V, Figure AA-5 is used. Entering the separation of 233 ft, the risk of collision when two ADG V aircraft are taxiing is approximately 2.3 E-08 (see Figure A-4), or one collision in 43,500,000 movements. The risk is lower than 1.0E-07 and therefore it is acceptable.

Section 2—Taxiway to Object

Procedure to Estimate Risk of Collision

1. Identify the taxiway and the object separation to be evaluated.

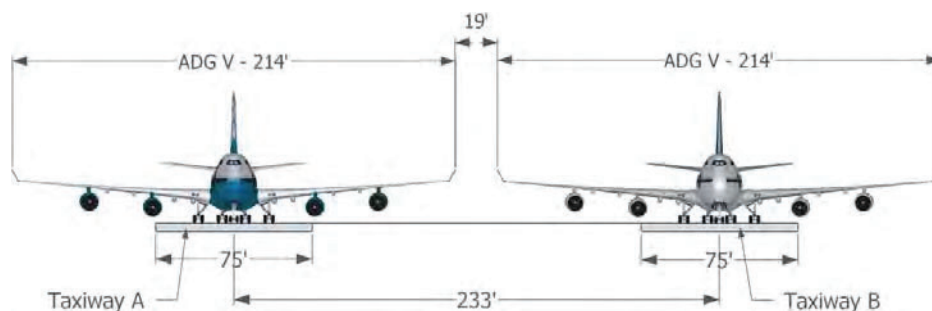

Figure A-3. Example of analysis for taxiway/taxiway separation.

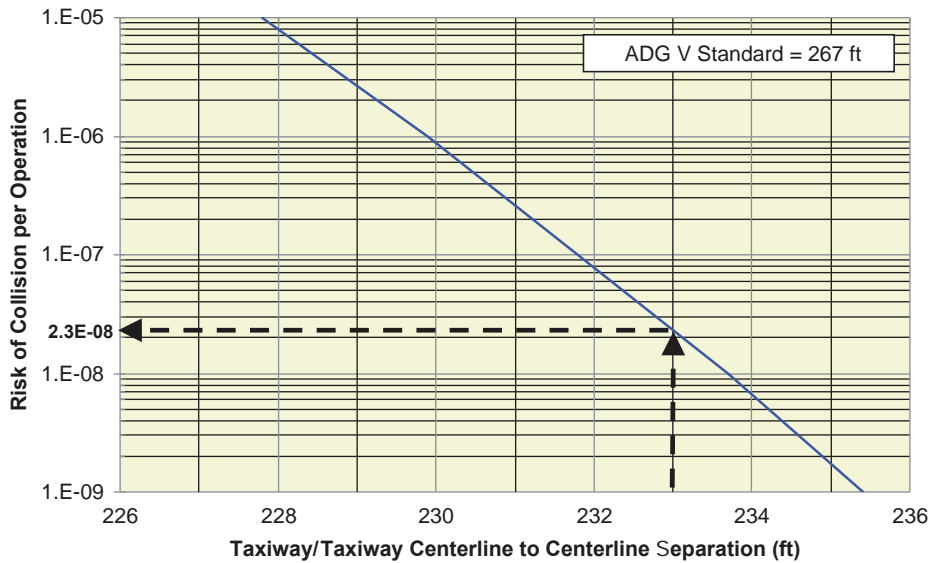

Figure A-4. Example of analysis of taxiway/taxiway separation (ADG V).

2. Identify the ADG for analysis or the aircraft with the largest wingspan that will be using the taxiway.
3. If the assessment is for a specific ADG, the simplified collision risk plots can be used based only on the centerline to object separation (Figures AA-8 to AA-13).
4. If the risk assessment involves a specific aircraft, the wingtip separation plot in Figure AA-14 should be used, and, in this case, the following steps will be required:
 - a. Place the aircraft at the taxiway centerline (see Figure A-5).
 - b. Calculate the wingtip clearance for this situation:

$$WD = CS - WS/2 \tag{2}$$

where

WD is the distance between the wingtip and the object when the aircraft is positioned at the centerline of the taxiway,

CS is the separation between the taxiway centerline and the object, and

WS is the aircraft wingspan.

- c. Using Figure AA-14, enter the wingtip separation and calculate the collision risk.

5. Compare the risk level estimated to 1×10^{-7} , the highest acceptable probability for risk of major consequences according to the risk matrix recommended by the FAA.

Example 2—Taxiway/Object Separation

An airport is planning to use an existing taxiway for ADG III aircraft; however, it currently is used by ADG II aircraft, and the separation between the taxiway and an existing service road is only 72 ft. The scenario is presented in Figure A-6. The airport does not have space to move the service road because it is limited by the airport perimeter fence. The standard separation for ADG III is 81 ft, and an MOS is necessary to evaluate whether the separation is safe.

For taxiway/object separation involving ADG III, Figure AA-10 is used. Entering the separation of 72 ft, the risk of collision when an ADG III aircraft is taxiing is approximately 1.0E-06 (see Figure A-7), or one collision in 1,000,000 movements. The risk is not acceptable based on the criterion of 1.0E-07; however, it may be possible to evaluate mitigation

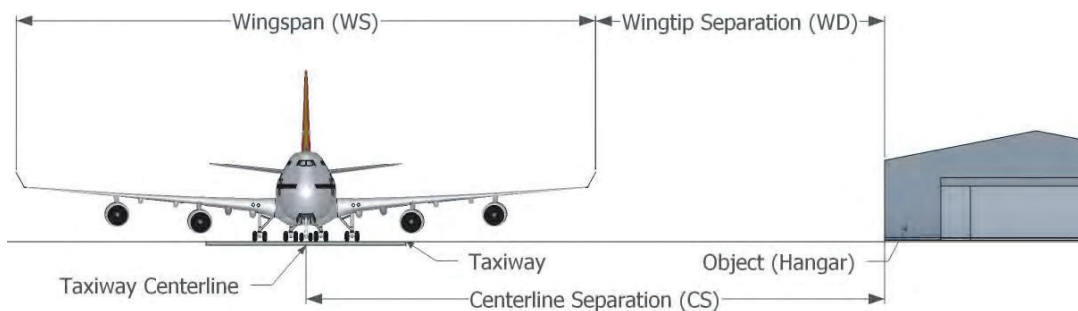

Figure A-5. Example of taxiway/object separation analysis for specific aircraft.

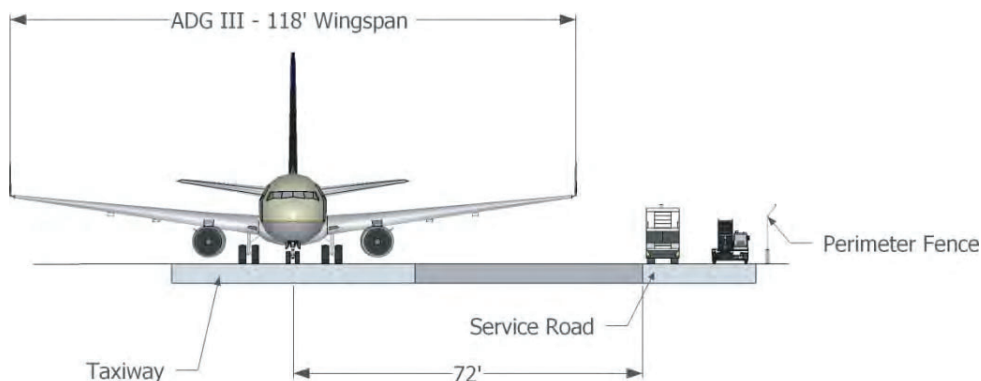

Figure A-6. Example of analysis for taxiway/object separation.

measures (e.g., restricting the wingspan of taxiing aircraft, using centerline lights) or to evaluate the expected number of years for one collision event based on the volume of operations in the taxiway.

For smaller airports with lower volumes of traffic, an accident may be expected to occur less than once every 100 years, and this condition is classified as extremely improbable. In this case, the risk may be considered acceptable according to the criteria suggested by the FAA.

Section 3—Taxilane to Taxilane

Procedure to Estimate Risk of Collision

1. Identify the taxilanes and the centerline separation to be evaluated.
2. Identify the ADG for analysis or the types of aircraft that will be using each taxilane. It is possible that each taxilane is assigned to a different ADG or specific aircraft.

3. If the assessment is for a specific ADG, the simplified collision risk plots can be used based only on the taxilane centerline separations (Figures AA-15 to AA-20).
4. If the risk assessment involves specific aircraft or two different types of aircraft, the wingtip separation plot in Figure AA-21 should be used, and, in this case, the following steps will be required:
 - a. Place both aircraft at the centerlines of the parallel taxilanes (see Figure A-8).
 - b. Calculate the wingtip clearance for this situation:

$$WD = CS - (WS1 + WS2) / 2 \quad (3)$$

where

WD is the distance between wingtips of the two aircraft when both are positioned at the centerline of the taxilanes, CS is the centerline separation between the parallel taxilanes, $WS1$ is the wingspan for the first aircraft, and $WS2$ is the wingspan for the second aircraft.

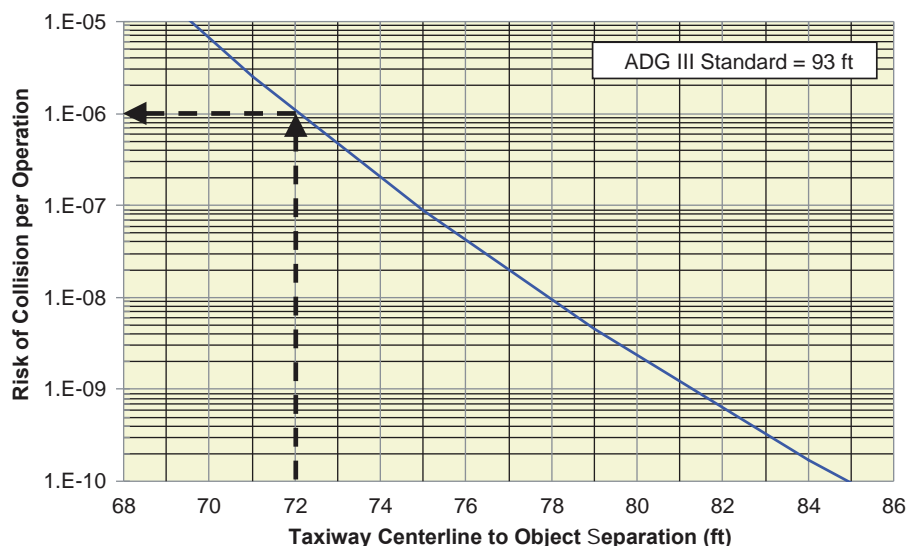

Figure A-7. Example of analysis for taxiway/object separation (ADG III).

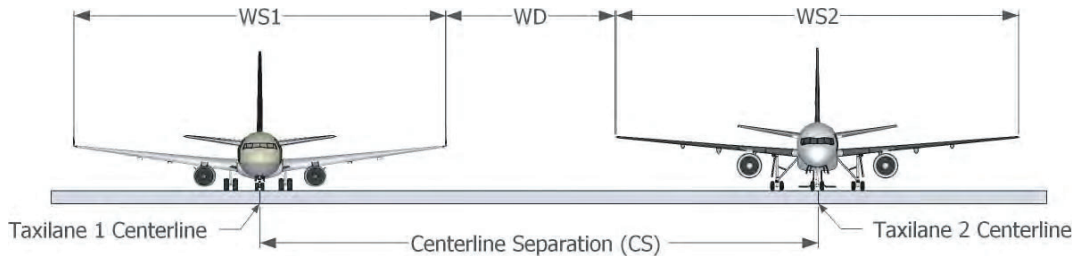

Figure A-8. Example of taxilane/taxilane separation analysis for specific aircraft.

- c. Using Figure AA-21, enter the wingtip separation and calculate the risk.
- 5. Using the risk level estimated, compare to 1×10^{-7} , the upper probability for risk of major consequences according to the risk matrix used by the FAA.

- c. Using Figure AA-28, enter the wingtip separation and calculate the collision risk.
- 5. Using the risk level estimated, compare to 1×10^{-7} , the upper probability for risk of major consequences according to the risk matrix used by the FAA.

Section 4—Taxilane to Object

Procedure to Estimate Risk of Collision

1. Identify the taxilane and the object separation to be evaluated.
2. Identify the ADG for analysis or the aircraft with the largest wingspan that will be using the taxilane.
3. If the assessment is for a specific ADG, the simplified collision risk plots can be used based only on the taxilane centerline to object separation (Figures AA-22 to AA-27).
4. If the risk assessment involves a specific aircraft, the wingtip separation plot in Figure AA-28 should be used, and, in this case, the following steps will be required:
 - a. Place the aircraft at the taxiway centerline (see Figure A-9).
 - b. Calculate the wingtip clearance for this situation:

$$WD = CS - WS/2 \tag{4}$$

where:

WD is the distance between the wingtip and the object when the aircraft is positioned at the centerline of the taxilane,

CS is the separation between the taxilane centerline and the object,

WS is the aircraft wingspan.

Section 5—Runway to Taxiway, Taxilane, or Object

The runway/taxiway, runway/taxilane, or runway/object separation has two scenarios: takeoff and landing. For landing operations, the analysis is divided into two parts: airborne (approach) phase and ground (landing rollout) phase. For takeoff operations, the analysis considers only the ground (takeoff roll) phase. In most cases, the runways are used for both landing and takeoff operations, and the analysis for takeoff operations will not be necessary because the risk of major lateral deviations during takeoff is lower than the risk during landing.

The airborne collision risk during the approach for landing is characterized using the FAA/ICAO CRM. A series of plots, one for each ADG, was developed to facilitate the use of this methodology.

For the landing ground roll phase, risk plots were derived based on a two-part model: frequency and location. Each plot integrates historical runway veer-off accident/incident rates with veer-off location models to simplify the use of this methodology. Given that the aircraft veered off the runway, the chance that the aircraft deviates more than a certain distance from the runway edge is given by the location model.

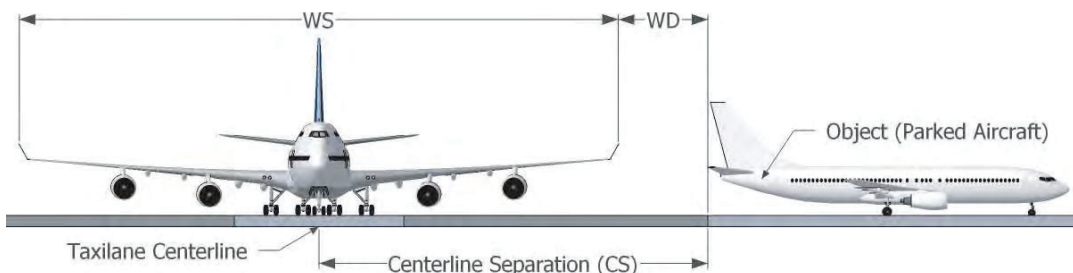

Figure A-9. Example of taxiway/object separation analysis for specific aircraft.

Table A-5. Average probability of occurrence by type of incident (U.S. data—1982 to 2009).

Type of Incident	Probability
Landing veer-off (LDVO)	1 per 837,002 landings
Takeoff veer-off (TOVO)	1 per 3,860,665 takeoffs

The combination of the frequency and location models will provide the probability that an aircraft will veer off the runway *and* deviate more than a given distance from the runway edge.

Table A-5 provides the average incident rates for landing and takeoff veer-offs.

It is also possible to use an alternative approach that may be more accurate but will require intensive calculations and the need to use an electronic spreadsheet or computer software. Details of the second approach can be found in the attachment to this appendix.

Subsection 5.1—Landing

For landing, it is necessary to estimate two types of risk: the risk of collision during the approach phase before the touchdown and the risk of collision during the ground phase in case the aircraft veers off the runway during the landing rollout. These two risks may be combined to provide the total risk. The veer-off risk is estimated for every landing operation, whereas the airborne risk is computed only for missed approaches under instrument conditions, which are assumed to be the worst scenario.

For the airborne phase, because this analysis is intended to evaluate the risk of collision between the approaching aircraft and an aircraft located in a parallel taxiway or an object, the analysis will focus only on the area within the immediate vicinity of the runway threshold and touchdown zone.

The basis for the analysis is the FAA/ICAO CRM and ranges of -300, 0, 750, 1,500, 3,000, and 4,500 ft along the runway, which were evaluated to develop the curves presented in Figures AA-29 to AA-34. The range corresponding to the negative number represents a distance before the runway end for an approaching aircraft, and positive values are for distances after the runway arrival end.

The plots provide the highest probability of collision during missed approaches under instrument (Cat I or Cat II) conditions. Although the CRM was developed in the 1970s and the FAA has made modifications to improve these models, the original CRM will serve as a screening tool to lead to further analysis by the FAA if the risk estimated is within a feasible range for additional analysis. The runs were made with obstacles located at various distances from the runway centerline and along the runway length.

The following steps apply to the estimation of risk during landings:

1. Calculate the risk during the airborne phase.
2. Calculate the risk during the landing rollout phase.
3. Calculate the total risk during landing.

Each of these steps is explained below.

5.1.1—Risk in Airborne Phase (Landing)

For this phase, the obstacle to the approaching aircraft is assumed to be another aircraft located in any segment of the parallel taxiway. This is a conservative assumption because, in most cases, the obstacle will be an aircraft moving on a parallel taxiway and the obstacle will have a small length compared to the total runway length.

Figure A-10 presents a typical scenario for this type of analysis. The plots are based only on the horizontal separation between the runway and taxiway centerlines, and the vertical separation is already considered in the plots presented in this section.

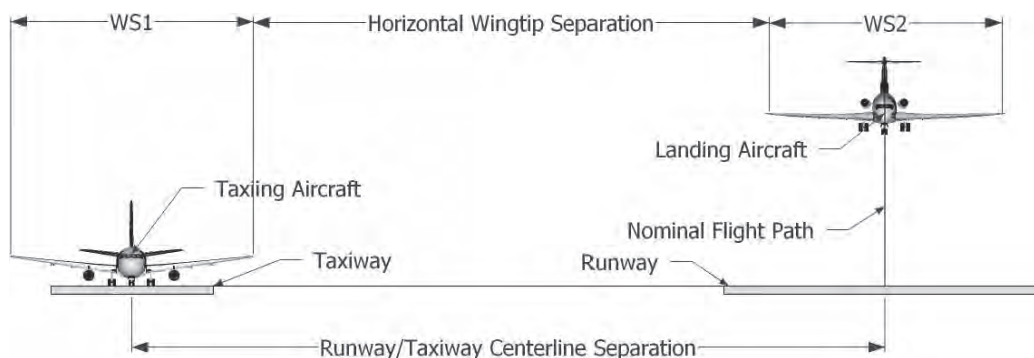

Figure A-10. Example of runway/taxiway separation analysis.

Procedure to Estimate Risk of Collision. The following presents the procedure to estimate risk of collision:

1. Identify the runway and the taxiway (or taxilane or object) centerline separation to be evaluated.
2. Identify the ADG for analysis based on the aircraft with the largest wingspan that will be using both the runway and the taxiway or taxilane.
3. Select the plot for the specific ADG involved and estimate the risk based only on the runway centerline to taxiway centerline separation (see Figures AA-29 to AA-40).
4. Using the risk level estimated, compare to 1×10^{-7} , the lowest probability for risk of severe consequences according to the risk matrix used by the FAA.

5.1.2—Risk in Ground Phase (Landing)

There are two alternatives that may be used to estimate the risk for the ground phase of landing, i.e., during the landing rollout. Alternative 1 is the default analysis and provides a simpler and direct estimate based upon generalized inputs. Alternative 2 provides a more accurate estimate for specific cases but also requires a significant amount of data and computation.

Procedure to Estimate Risk of Collision. The following are the steps to estimate risk for the landing rollout phase. For Alternative 1 (Default):

1. Figures AA-41 to AA-47 represent the risk curves that integrate both the frequency and location models for the specific case.
2. Characterize the separation between the runway centerline and the parallel taxiway, parallel taxilane, or object.
3. Characterize the ADG involved in the analysis.
4. Select the correct plot for the ADG involved in the analysis.
5. Enter the centerline separation to obtain the risk of collision in the plot selected.

For Alternative 2:

1. Obtain 1 year of historical landing operational data and information on weather conditions for the runway.

2. Calculate the frequency of landing veer-offs for the runway by applying the frequency model (see “Event Probability” and Table 7 in Chapter 4).
3. Calculate the probability that the aircraft veers off beyond a given distance:
 - a. Obtain the wingtip clearance WD between the aircraft landing and the nearest obstacle, as shown in Figures A-11 and A-12, by placing the center of the aircraft landing at the edge of the runway.
 - b. Use WD and apply the location model (see Table 10) to calculate the probability of a lateral deviation beyond WD .
4. Multiply the frequency probability by the location probability and repeat Steps 2 and 3 for each historical landing operation on the runway.
5. Calculate the average value for the probabilities estimated with historical landing data for the runway.

$$WD = CS - RW/2 - (WS1 + WS2)/2 \quad (5)$$

where

WD is the wingtip distance,

CS is the separation between the runway and the taxiway,

RW is the runway width,

$WS1$ is the wingspan for the aircraft taking off, and

$WS2$ is the wingspan for the aircraft in the parallel taxiway.

If the analysis is for a specific ADG, WD can be picked up from Table A-6.

Another possibility is the evaluation of separation between the runway and an object. Figure A-12 shows an example using a runway and a service road. In this case, the wingtip separation is calculated using Equation 6:

$$WD = CS - RW/2 - SW/2 - WS/2 \quad (6)$$

where

WD is the wingtip separation,

CS is the separation between the runway and the service road,

RW is the runway width,

SW is the width of the service road, and

WS is the wingspan of the aircraft.

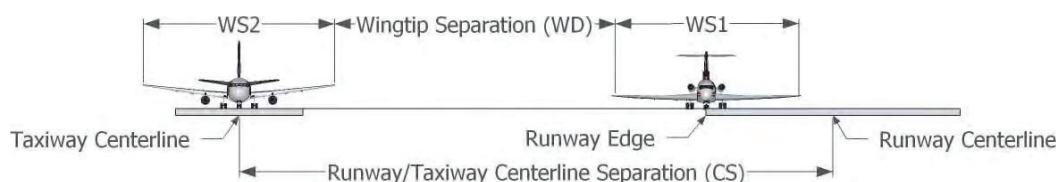

Figure A-11. Typical runway/taxiway scenario for runway veer-off incidents.

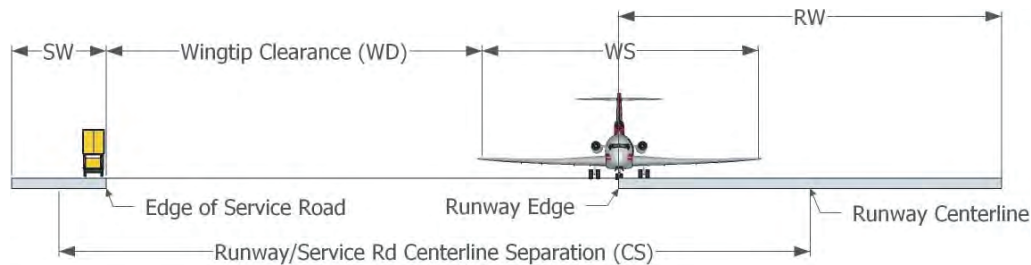

Figure A-12. Typical runway/object scenario for runway veer-off incidents.

The frequency and location models for veer-off are presented in Tables 7 and 10.

Subsection 5.2—Takeoff

For takeoff, the risk is that an aircraft will veer off the runway and strike an obstacle in the vicinity of the runway obstacle free zone (OFZ). In this case, the obstacle is assumed to be an aircraft or another object (fixed or movable) that is closest to the runway centerline. This is a conservative assumption because an aircraft may not be present in the parallel taxiway, and the obstacle has a small length compared to the total runway length.

Analysis for takeoff is only applicable to runways with departure operations only. This is because when the runway is used for both landing and takeoff, the highest risk condition is for landing.

Similar to the case for landings, there are two alternatives for estimating the risk of collision. Alternative 1 is the default analysis and is simple and direct, based upon generalized inputs. Alternative 2 provides a more accurate estimate that takes into account specific operation conditions for the airport; however, it requires a significant amount of data and computation.

Procedure to Estimate Risk of Collision. The following are the steps to estimate risk for the takeoff roll phase for Alternative 1 (Default):

1. Figures AA-48 to AA-54 represent the risk curves that integrate both the frequency and location models for the specific case.
2. Characterize the separation between the runway centerline and the parallel taxiway, parallel taxilane, or object.
3. Characterize the ADG involved in the analysis.
4. Select the correct plot for the ADG involved in the analysis.
5. Enter the centerline separation to obtain the risk of collision in the plot selected.

For Alternative 2:

1. Obtain 1 year of historical takeoff operational data and information on weather conditions for the runway.
2. Calculate the frequency of takeoff veer-off for the runway by applying the frequency model (see “Event Probability” and Table 7 in Chapter 4).
3. Calculate the probability that the aircraft veers off beyond a given distance:
 - a. Obtain the wingtip clearance *WD* between the aircraft taking off and the nearest obstacle, as shown in Figures A-11 and A-12, by placing the center of the aircraft landing at the edge of the runway.
 - b. Use *WD* and apply the location model (see Table 10) to calculate the probability of a lateral deviation beyond *WD*.
4. Multiply the frequency probability by the location probability and repeat Steps 2 and 3 for each historical takeoff operation on the runway.
5. Calculate the average value for the probabilities estimated with historical takeoff data for the runway.

Table A-6. Wingtip separation based on largest wingspan in ADG.

ADG	RW ft	WD ft
I	100	CS-99
II	100	CS-129
III	100	CS-168
IV	150	CS-246
V	150	CS-289
VI	200	CS-362

Example 3—Runway/Taxiway Separation

In this example, an ADG II airport wants to bring regular flights of ERJ-170 aircraft. The runway is 150 ft wide and has a Cat I instrument landing system (ILS). The wingspan of an ERJ-170 is 85.3 ft, and it is classified in ADG III. The existing separation between the runway and the parallel taxiway centerlines is 320 ft; however, the standard for

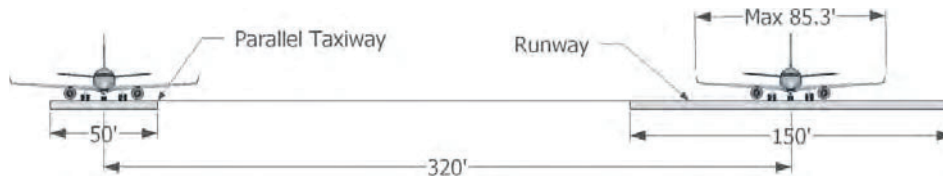

Figure A-13. Example of Runway/Taxiway Separation.

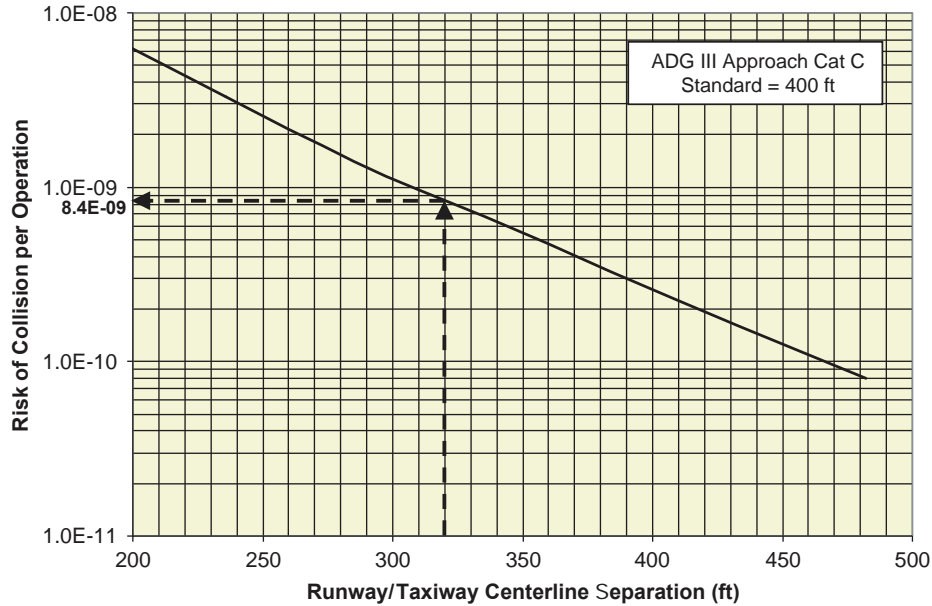

Figure A-14. Estimating airborne risk of runway/taxiway separation (ADG III-CAT I).

ADG III aircraft is 400 ft. The scenario is illustrated in Figure A-13.

The analysis involves a two-step process. In the first step, it is necessary to evaluate the risk during the airborne phase, and, in the second step, it is necessary to estimate the risk for aircraft veer-off during the landing roll.

The risk of collision for ADG III Cat I during the airborne phase of landing is estimated using Figure AA-33. The runway/taxiway centerline separation for the case is 320 ft, and the

risk of collision is 8.4E-9 (see Figure A-14), or one chance in 119 million landings. This level is considered acceptable according to the FAA risk matrix.

The final step is to estimate risk of collision in case the aircraft veers off the runway. Figure AA-43 is used for ADG III aircraft, and the separation of 320 ft is entered to estimate the risk of collision of 9.0E-08 (or one chance in 11.1 million landings). As this risk is lower than 1.E-07, it may be acceptable to the FAA.

ATTACHMENT—RISK PLOTS

This attachment contains several plots that should be used with the methodology described in Appendix A.

The input parameter is always the centerline separation or the wingtip clearance in feet. The output of these plots is the risk of collision. The scale for the risk values is logarithmic. When the analysis involves one specific ADG, the centerline separation should be entered. In an example plot (see Exhibit AA-1), a text box con-

tains the current FAA standard separation for the specific scenario.

Exhibit AA-1 also illustrates the use of these plots. To estimate the risk of collision when the centerline separation of two parallel taxiways used by aircraft in ADG I is 65 ft, use the plot shown in Figure AA-1 to enter the centerline separation and move vertically until crossing the curve. Then move horizontally to read the risk of collision—in this example, it is approximately $9.0E-07$, or 9 events in 10,000,000 operations. The procedure is illustrated in Exhibit AA-1.

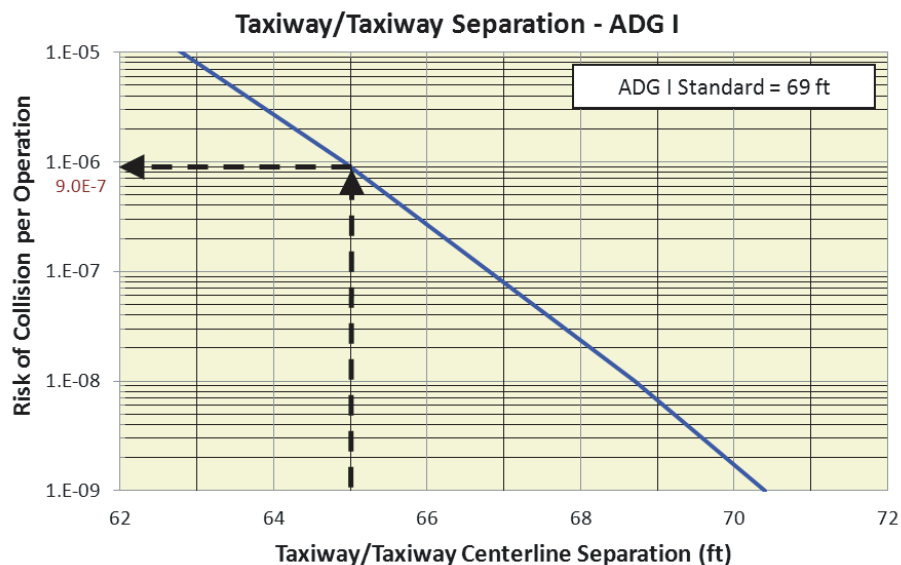

Exhibit AA-1. Example illustrating use of plots.

Section 1—Taxiway to Taxiway/Taxilane Risk Plots

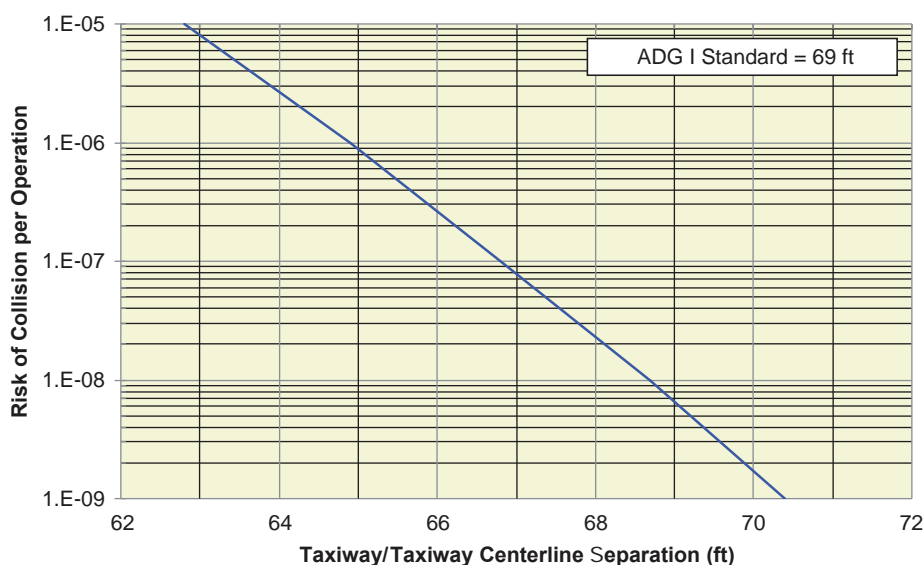

Figure AA-1. Collision risk associated with taxiway centerline separation for ADG I.

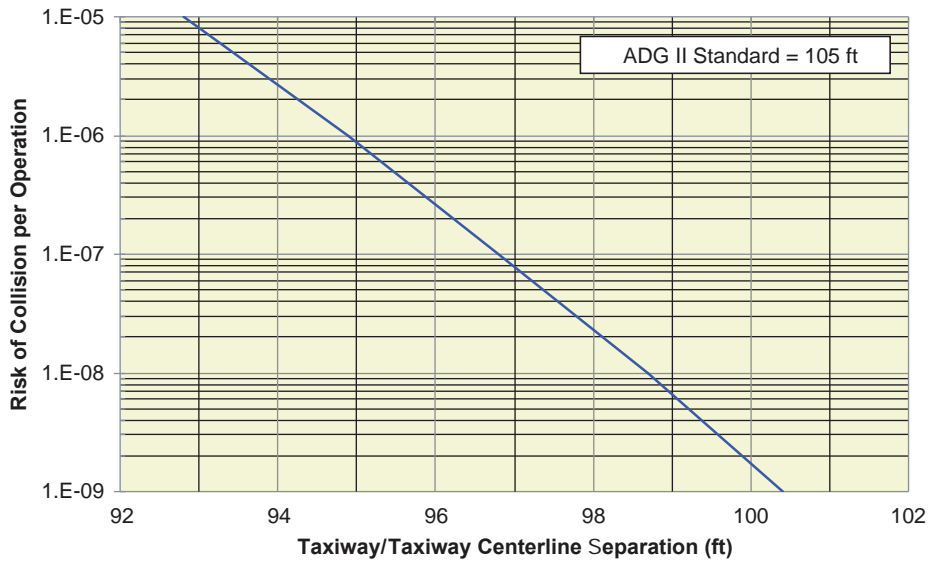

Figure AA-2. Collision risk associated with taxiway centerline separation for ADG II.

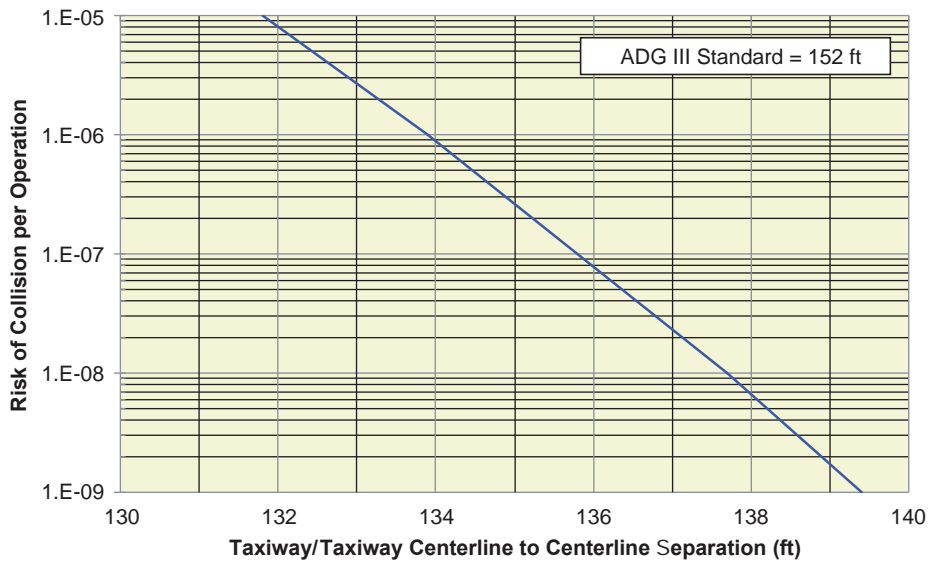

Figure AA-3. Collision risk associated with taxiway centerline separation for ADG III.

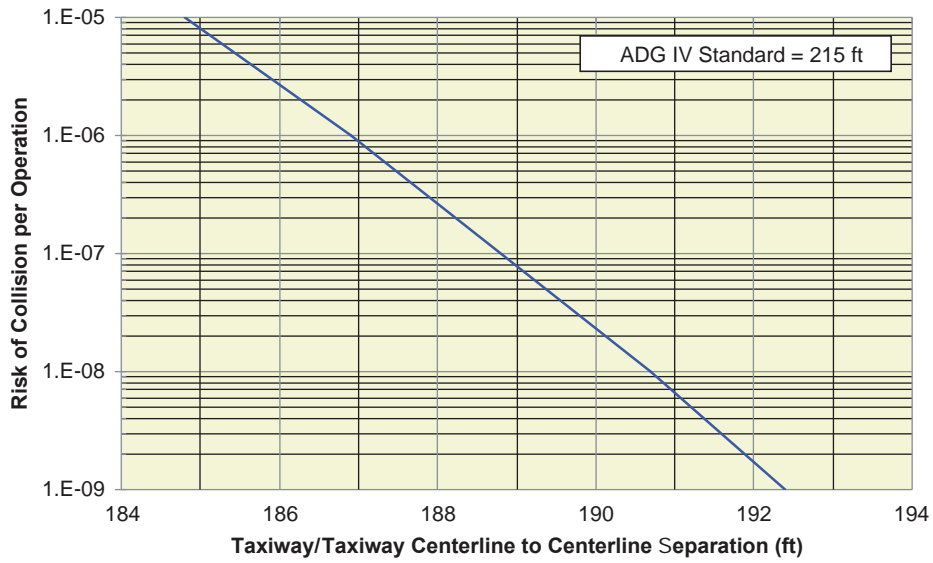

Figure AA-4. Collision risk associated with taxiway centerline separation for ADG IV.

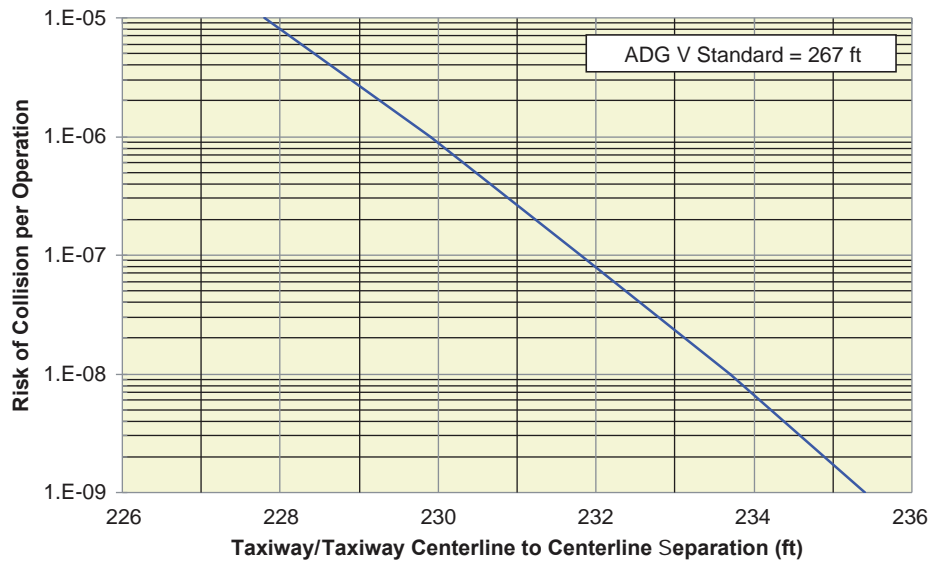

Figure AA-5. Collision risk associated with taxiway centerline separation for ADG V.

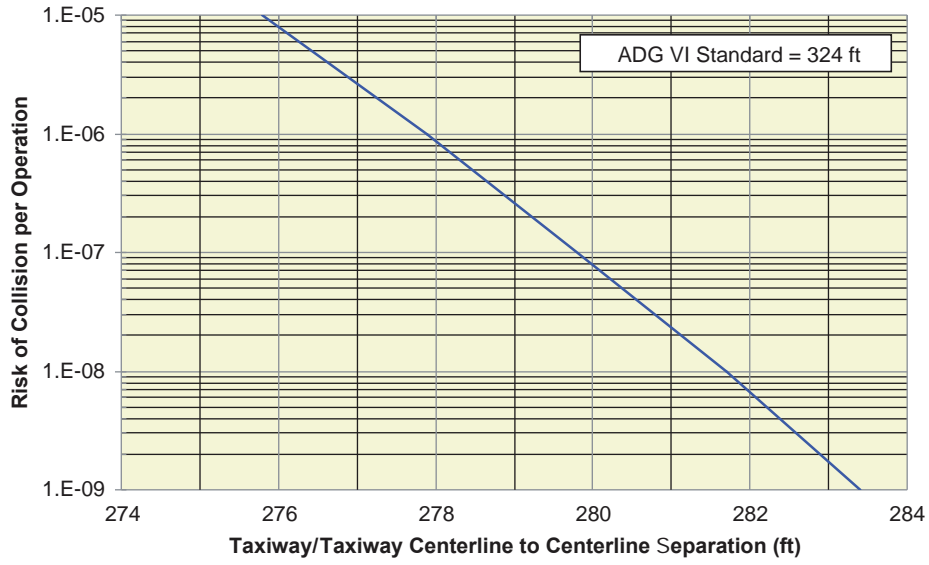

Figure AA-6. Collision risk associated with taxiway centerline separation for ADG VI.

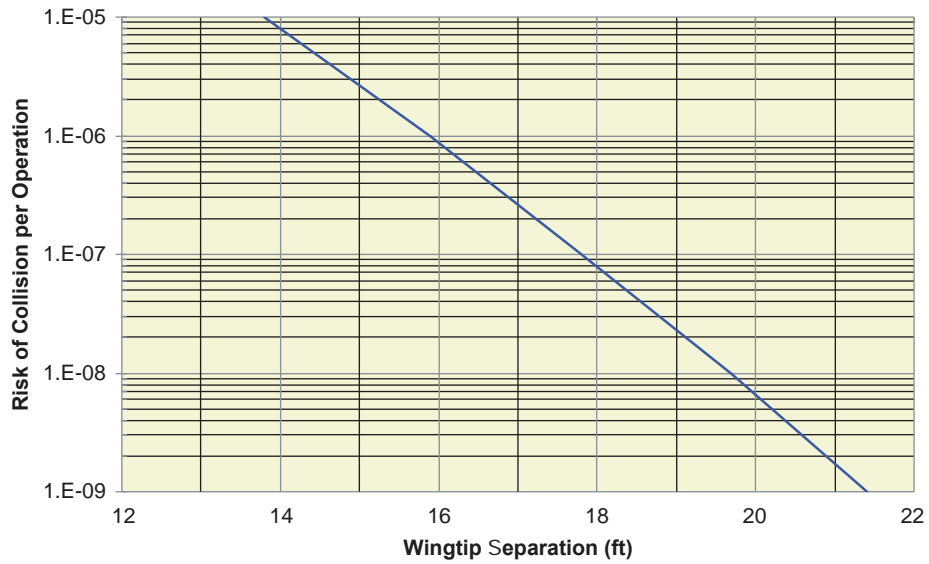

Figure AA-7. Collision risk associated with wingtip separation distance (Any ADG).

Section 2—Taxiway to Object Risk Plots

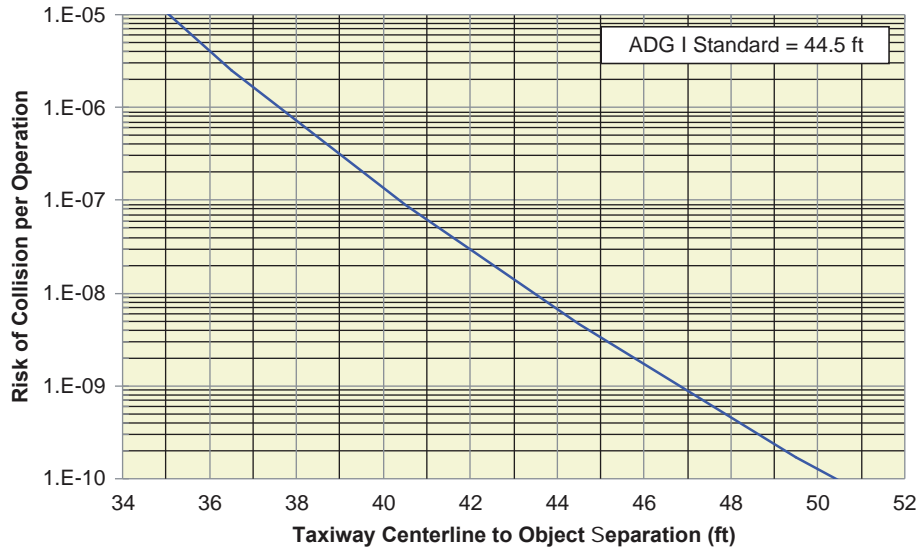

Figure AA-8. Collision risk associated with taxiway to object separation for ADG I.

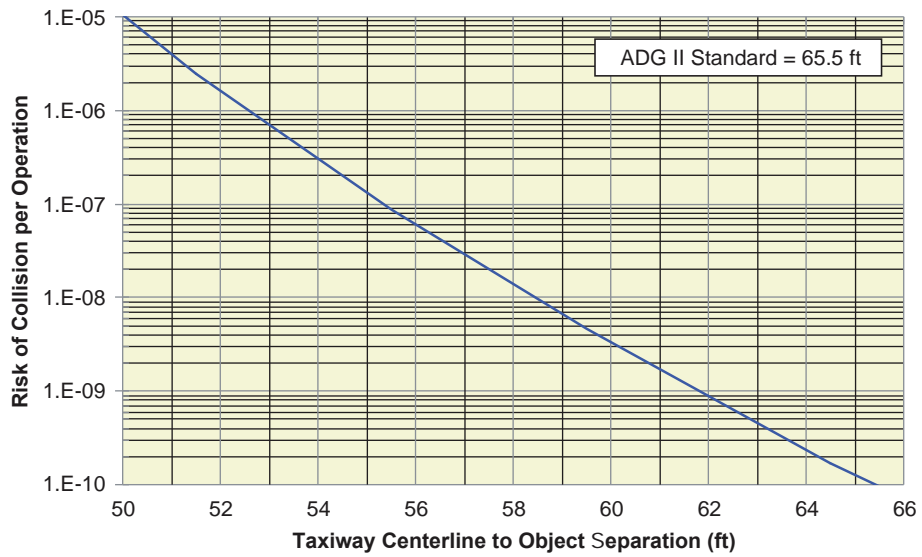

Figure AA-9. Collision risk associated with taxiway to object separation for ADG II.

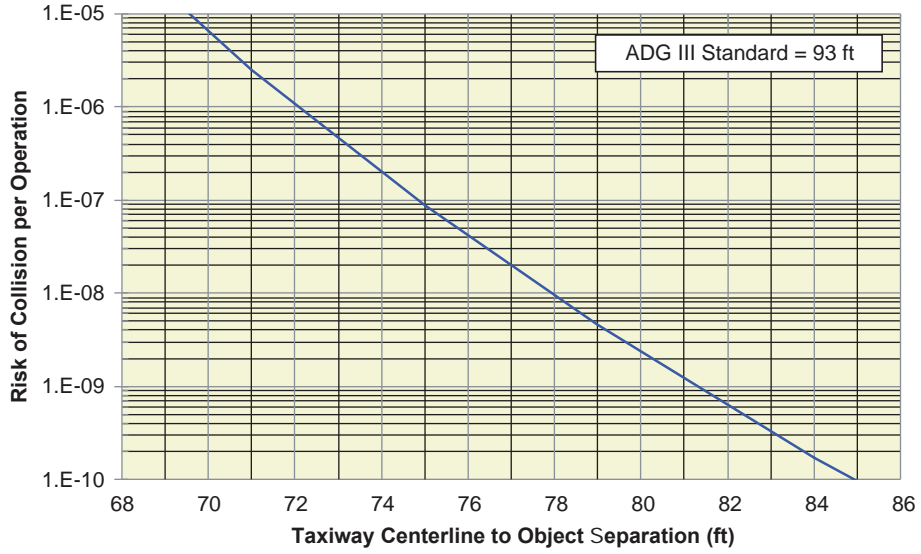

Figure AA-10. Collision risk associated with taxiway to object separation for ADG III.

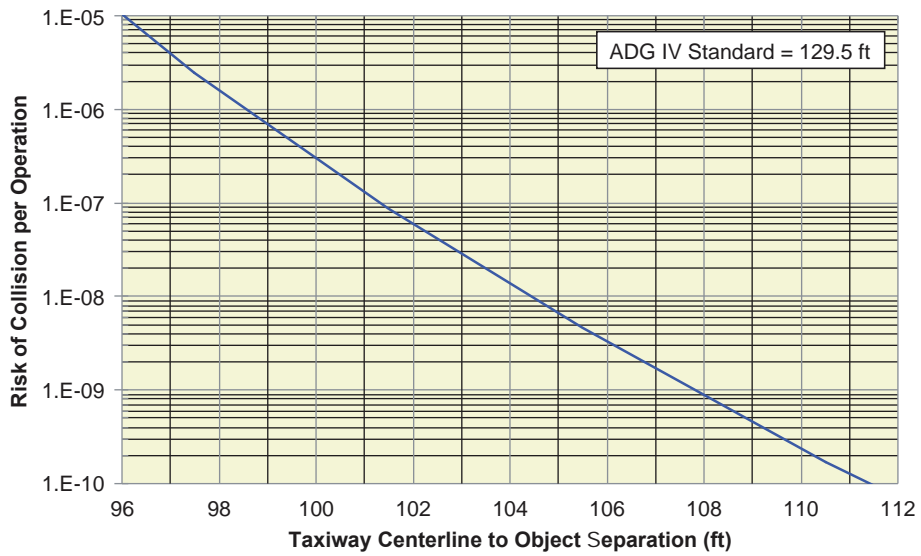

Figure AA-11. Collision risk associated with taxiway to object separation for ADG IV.

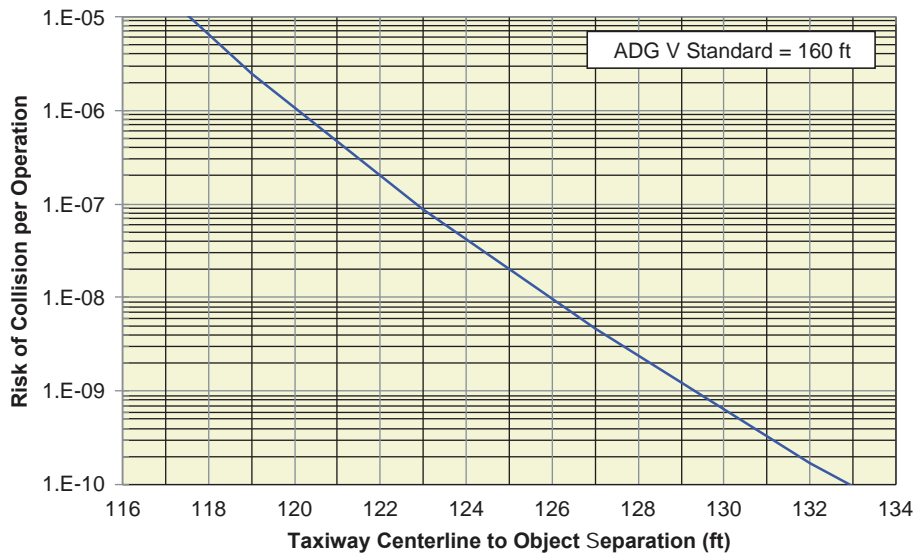

Figure AA-12. Collision risk associated with taxiway to object separation for ADG V.

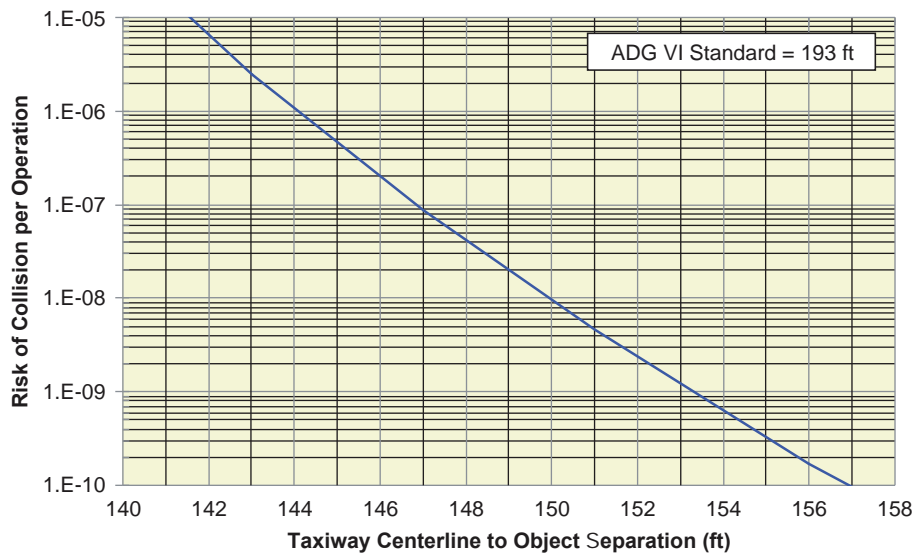

Figure AA-13. Collision risk associated with taxiway to object separation for ADG VI.

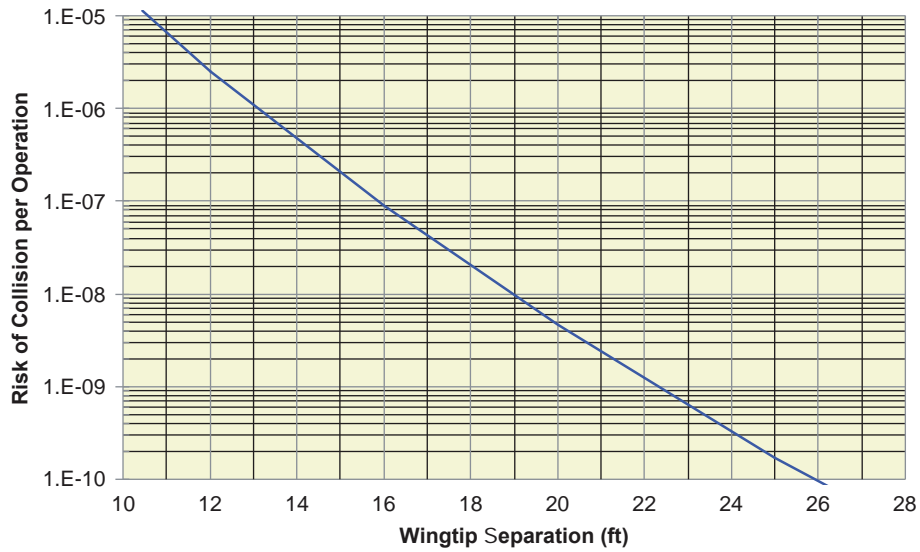

Figure AA-14. Collision risk associated with taxiway wingtip to object clearance (any ADG).

Section 3—Taxilane to Taxilane Risk Plots

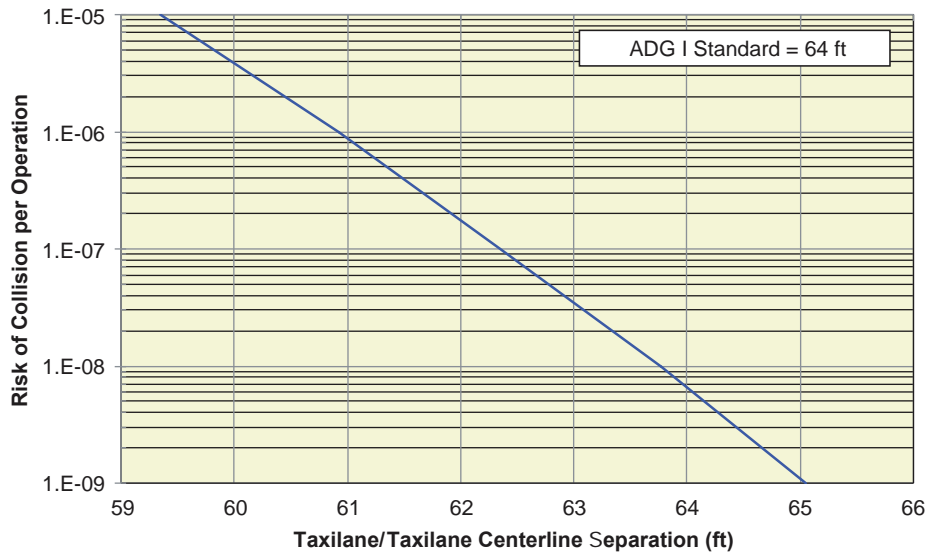

Figure AA-15. Collision risk associated with taxilane to object separation for ADG I.

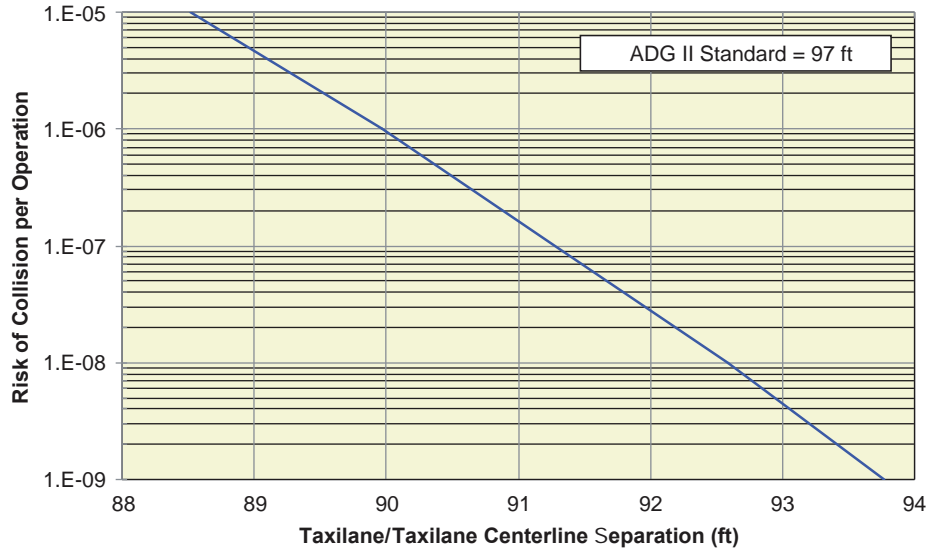

Figure AA-16. Collision risk associated with taxilane to object separation for ADG II.

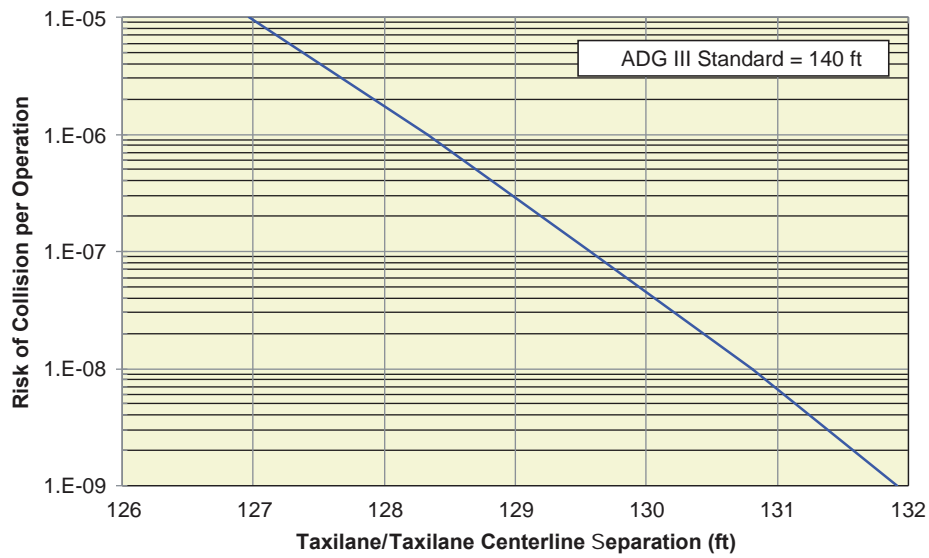

Figure AA-17. Collision risk associated with taxilane to object separation for ADG III.

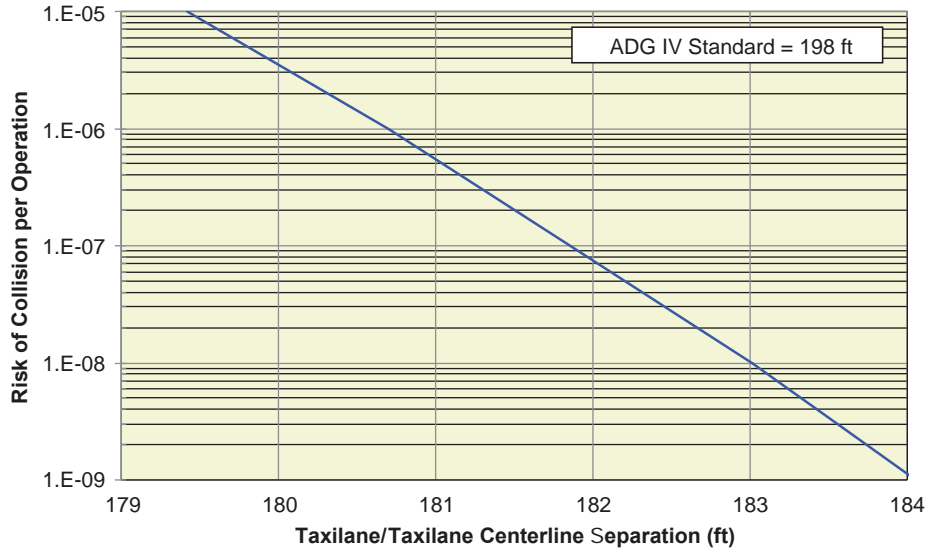

Figure AA-18. Collision risk associated with taxilane to object separation for ADG IV.

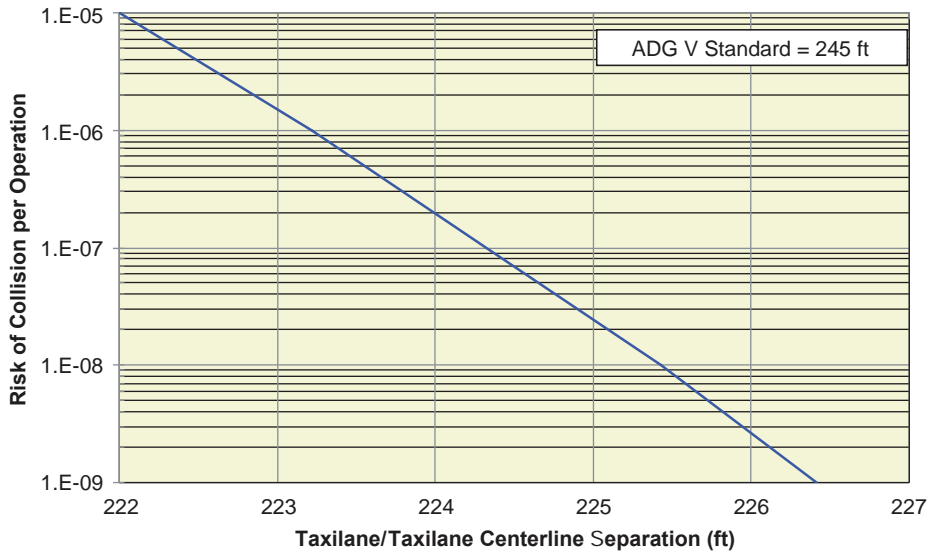

Figure AA-19. Collision risk associated with taxilane to object separation for ADG V.

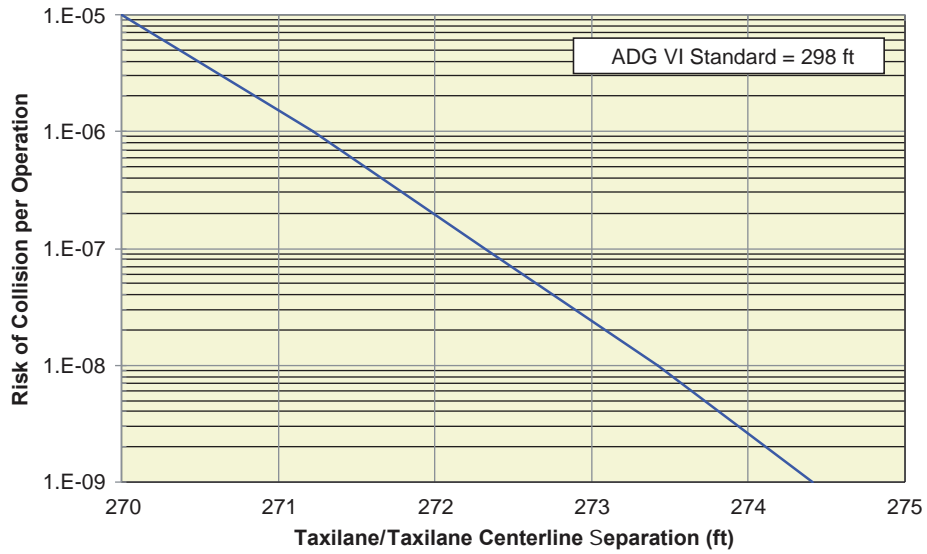

Figure AA-20. Collision risk associated with taxilane to object separation for ADG VI.

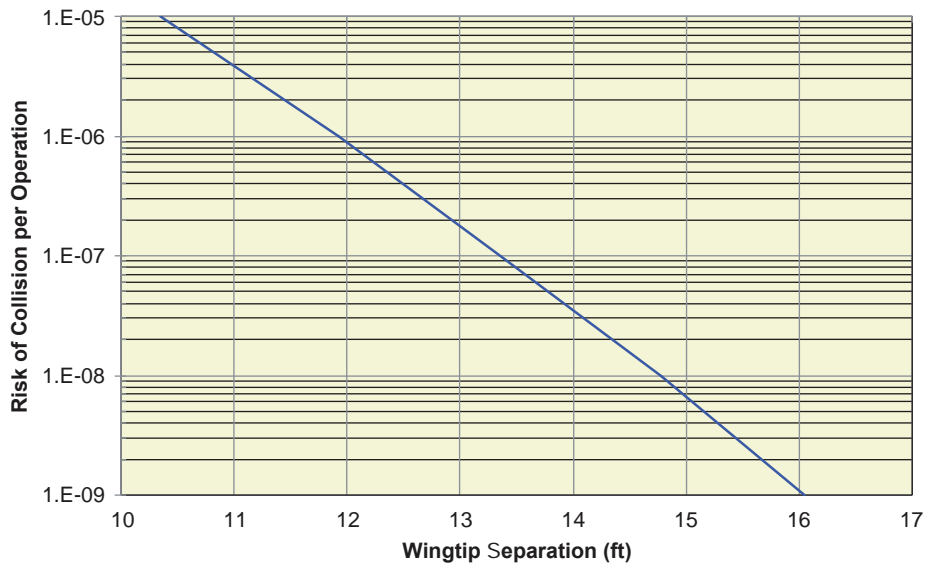

Figure AA-21. Collision risk associated with taxilane wingtip separation distance (any ADG).

Section 4—Taxilane to Object Risk Plots

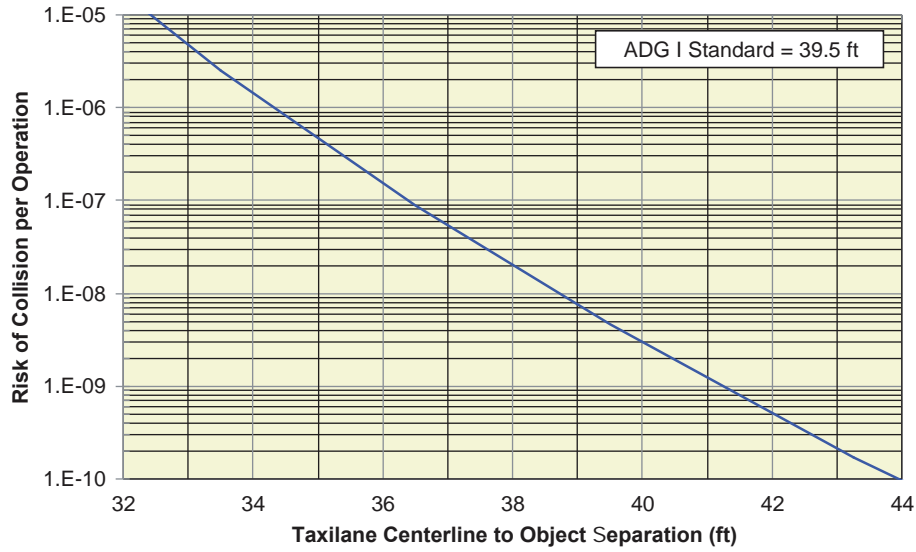

Figure AA-22. Collision risk associated with taxilane to object separation for ADG I.

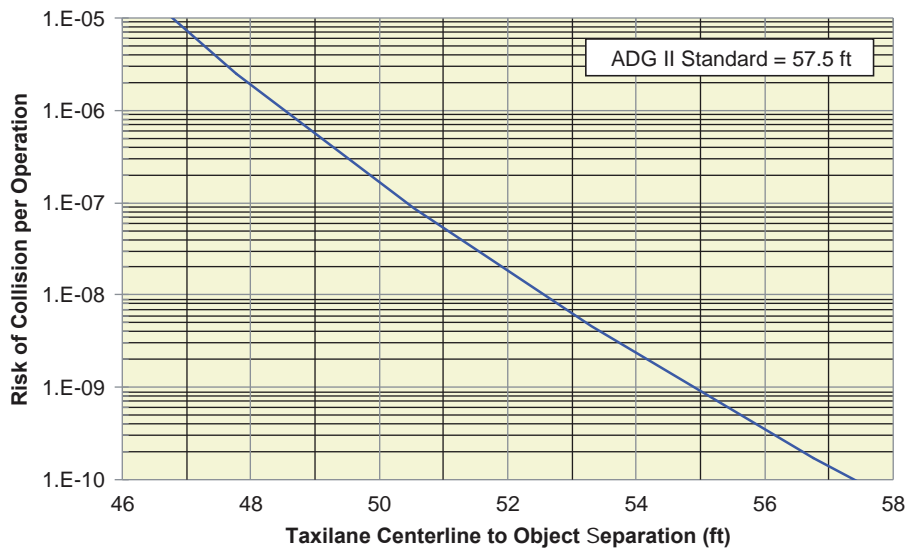

Figure AA-23. Collision risk associated with taxilane to object separation for ADG II.

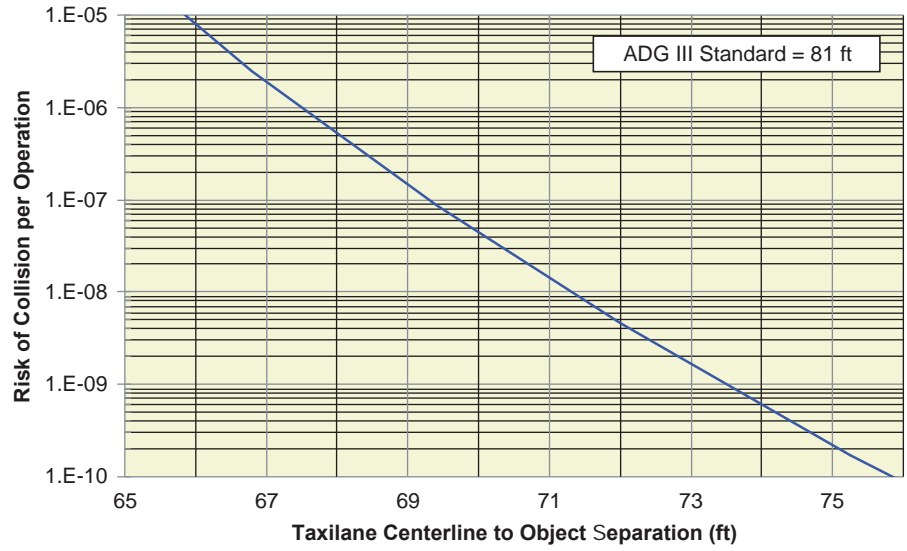

Figure AA-24. Collision risk associated with taxilane to object separation for ADG III.

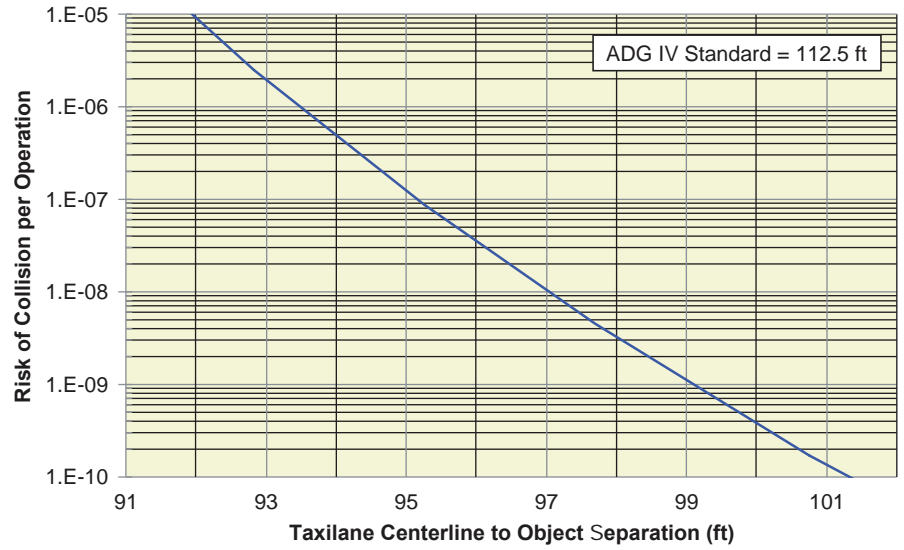

Figure AA-25. Collision risk associated with taxilane to object separation for ADG IV.

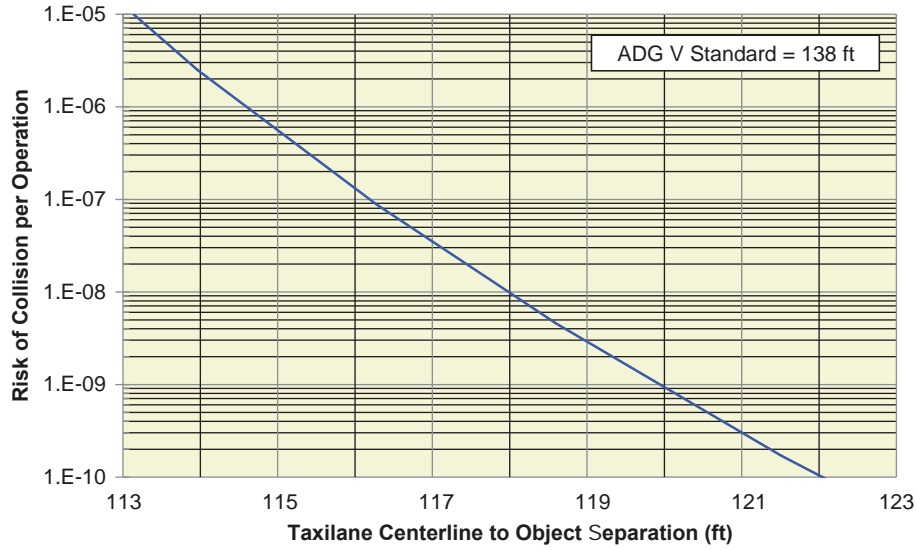

Figure AA-26. Collision risk associated with taxilane to object separation for ADG V.

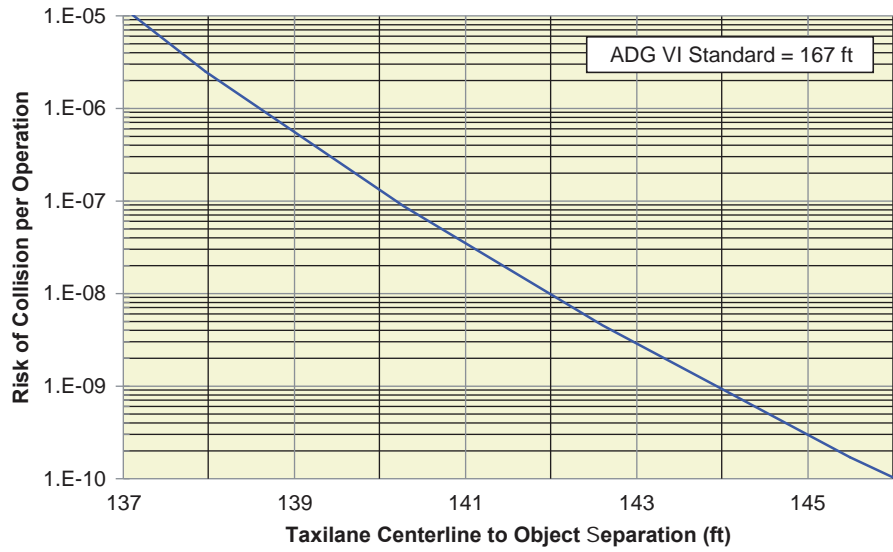

Figure AA-27. Collision risk associated with taxilane to object separation for ADG VI.

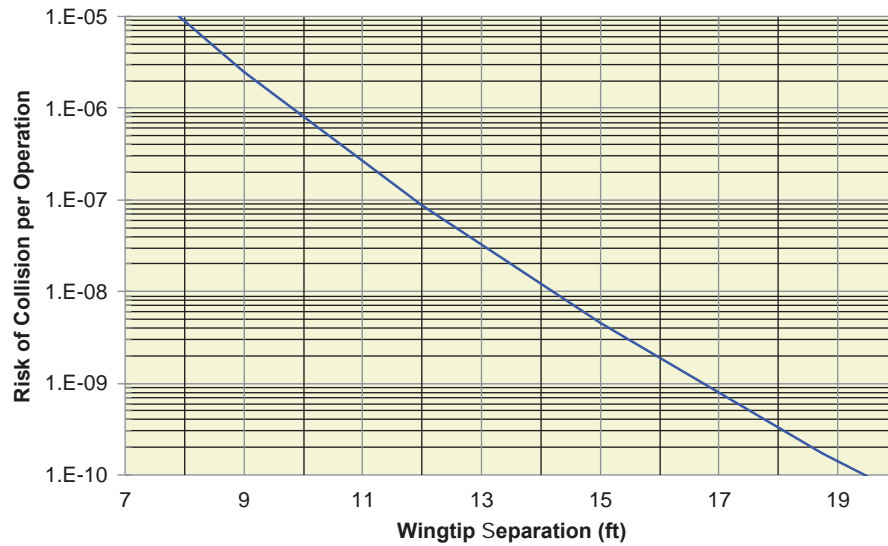

Figure AA-28. Collision risk associated with taxilane wingtip to object clearance—any ADG.

Section 5.1.1—Runway to Taxiway, Taxilane, or Object Risk in Airborne Phase (Plots Based on FAA/ICAO CRM)

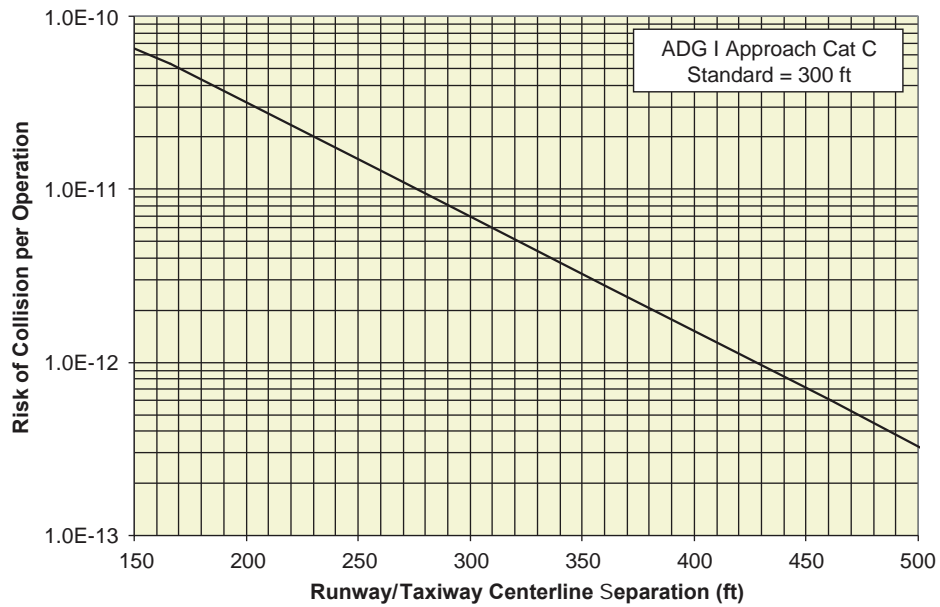

Figure AA-29. Missed approach collision risk for ADG I Cat I.

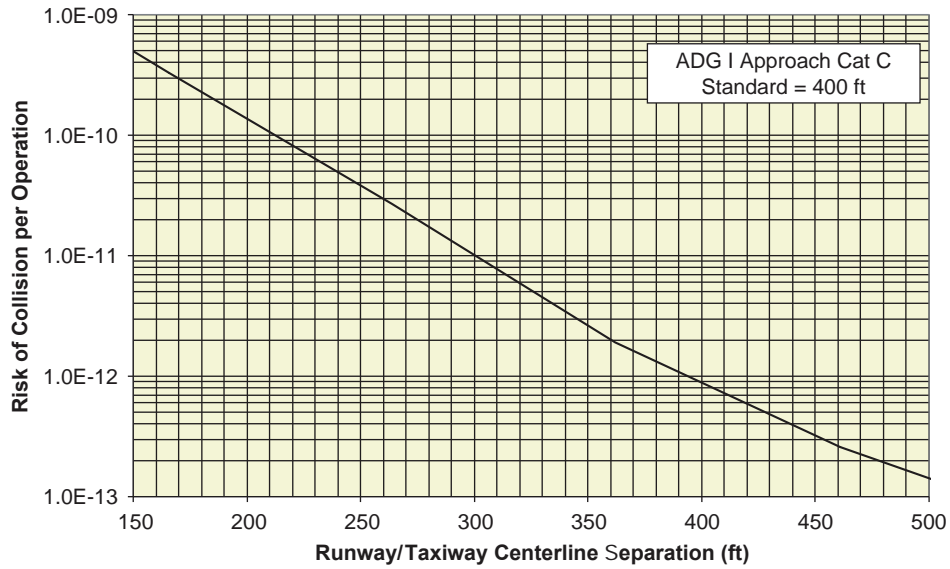

Figure AA-30. Missed approach collision risk for ADG I Cat II.

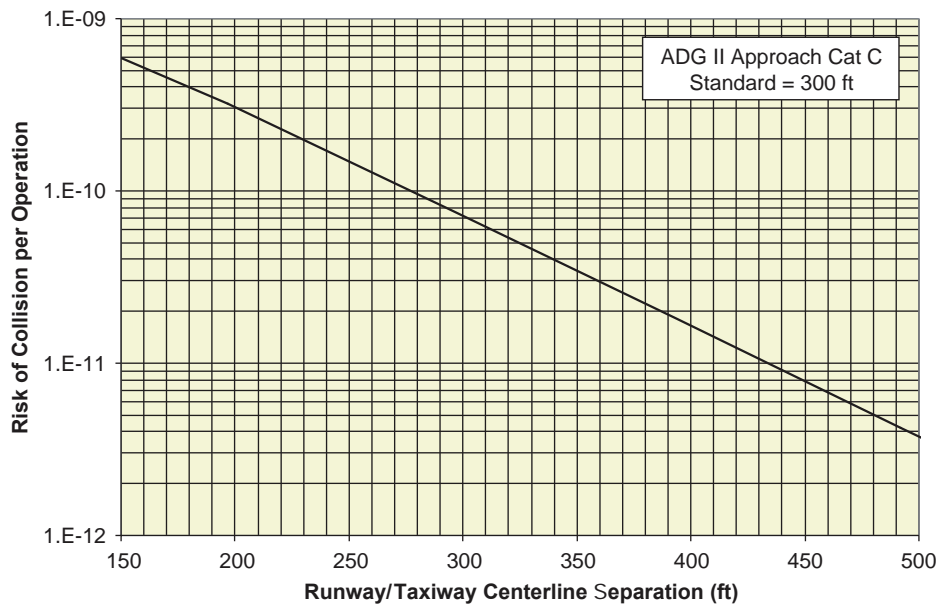

Figure AA-31. Missed approach collision risk for ADG II Cat I.

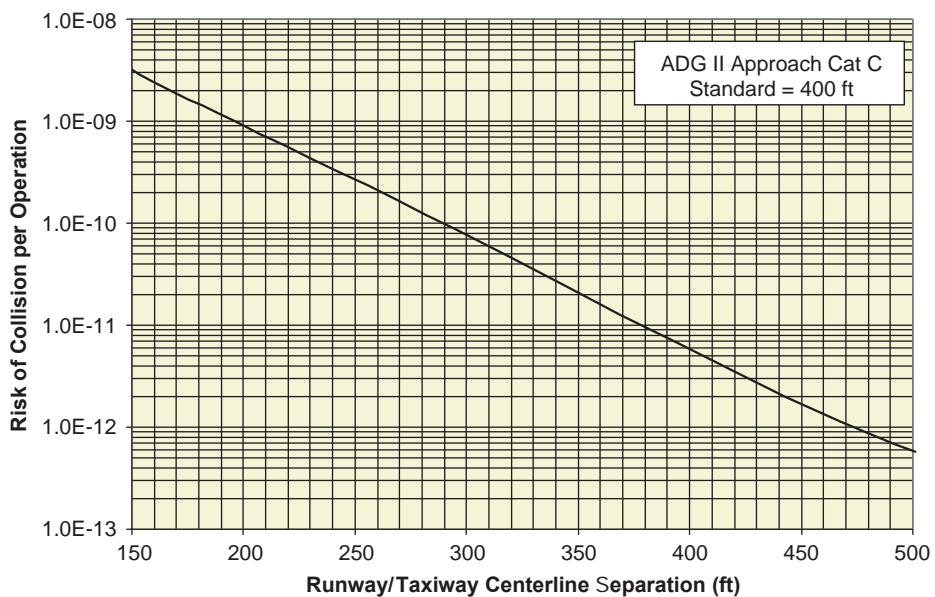

Figure AA-32. Missed approach collision risk for ADG II Cat II.

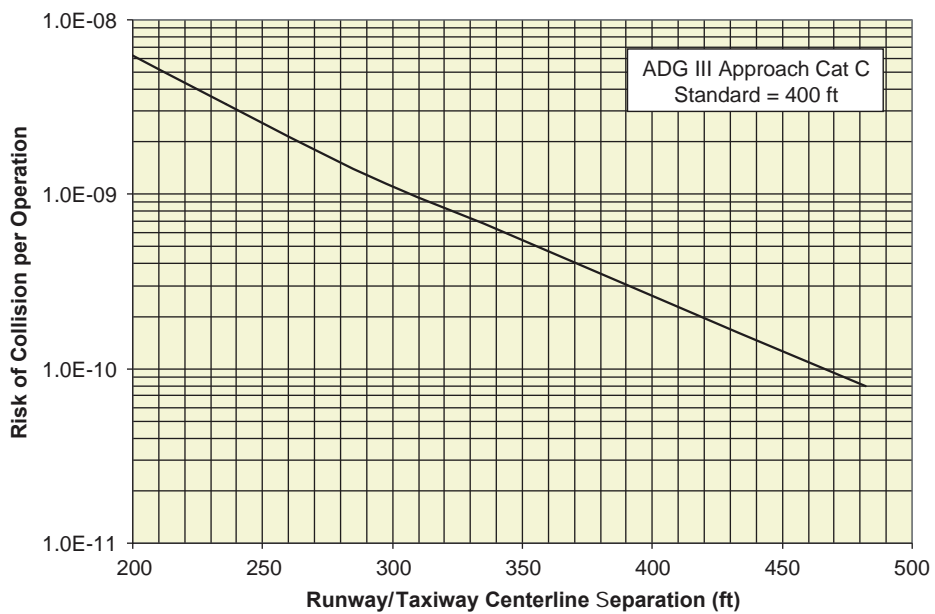

Figure AA-33. Missed approach collision risk for ADG III Cat I.

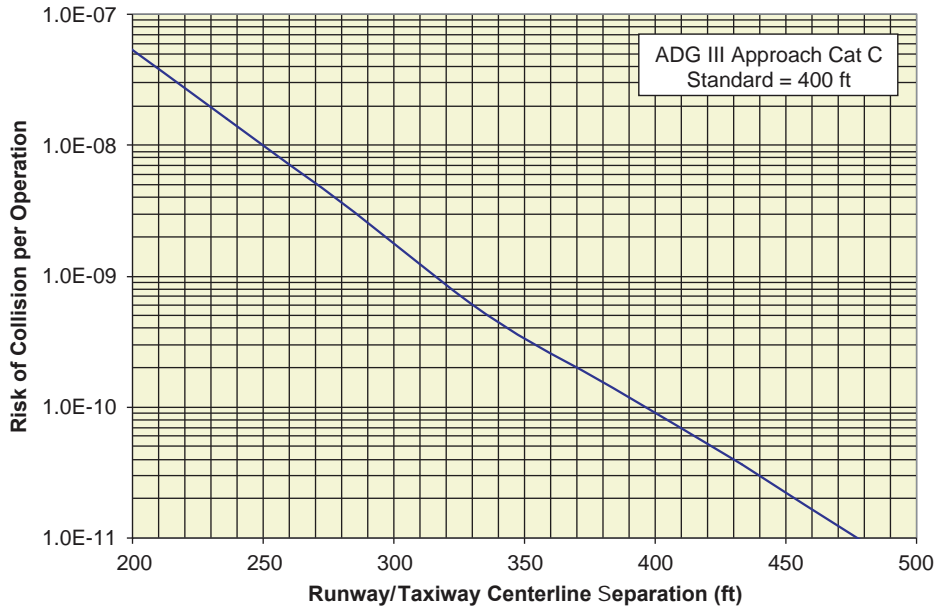

Figure AA-34. Missed approach collision risk for ADG III Cat II.

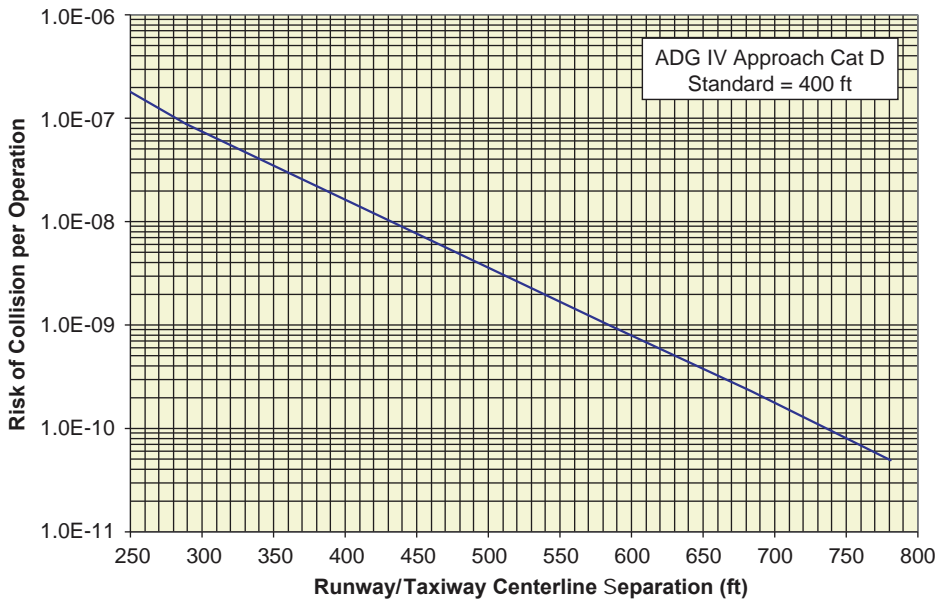

Figure AA-35. Missed approach collision risk for ADG IV Cat I.

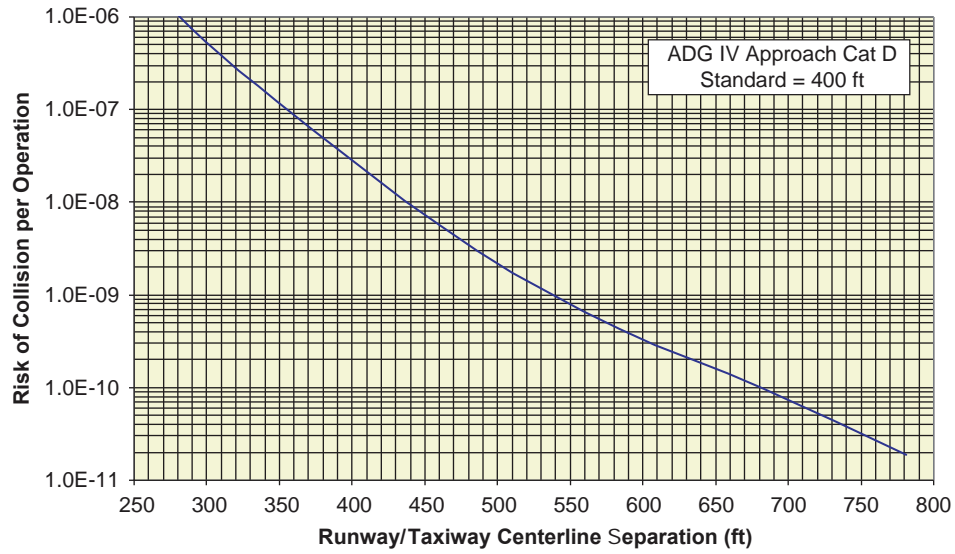
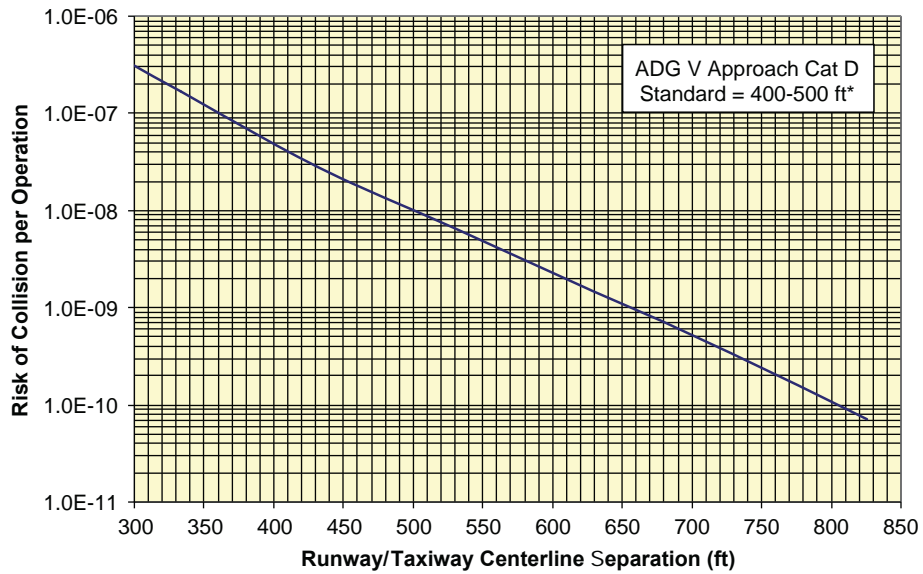
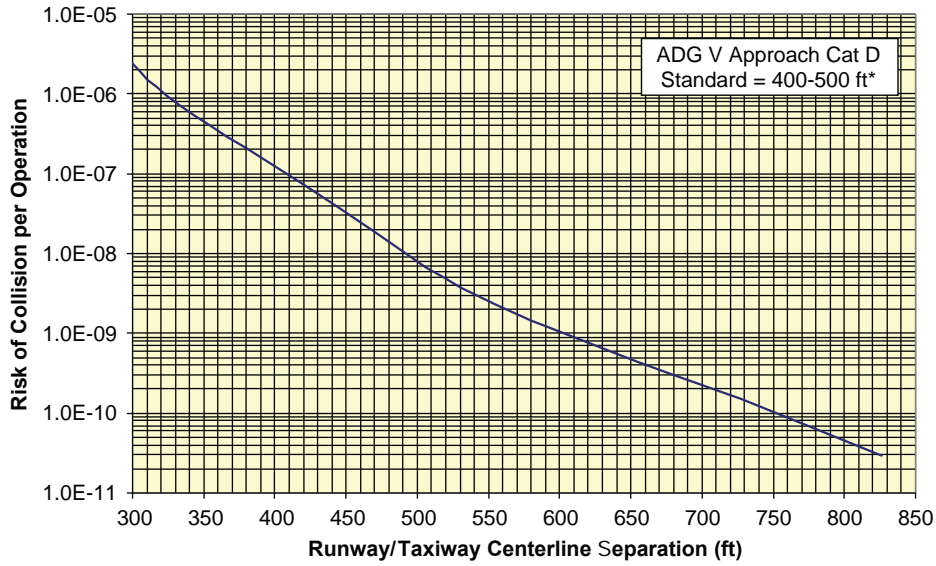

Figure AA-36. Missed approach collision risk for ADG IV Cat II.



For specific standard, please check Table 2-2 in FAA AC 150/5300-13.

Figure AA-37. Missed approach collision risk for ADG V Cat I.



For specific standard, please check Table 2-2 in FAA AC 150/5300-13.

Figure AA-38. Missed approach collision risk for ADG V Cat II.

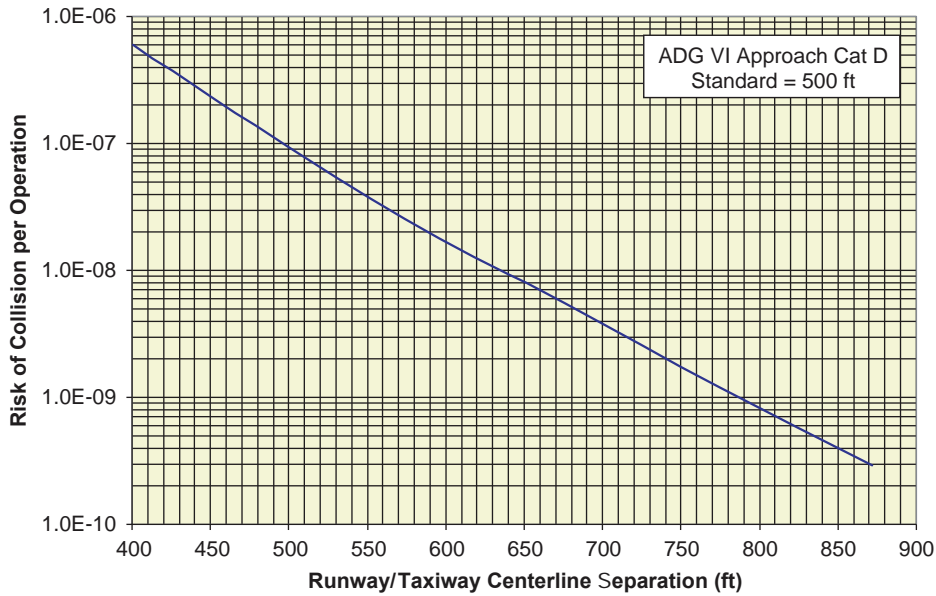
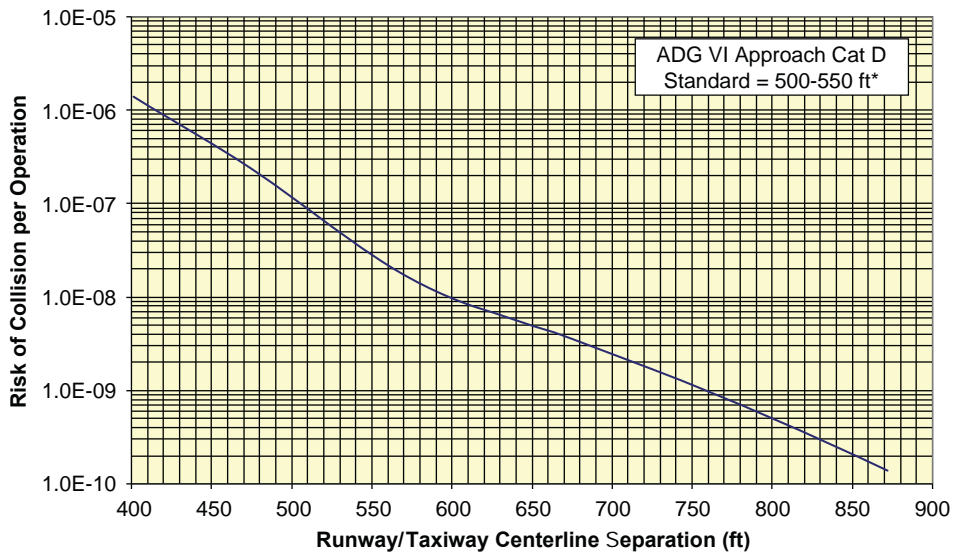

Figure AA-39. Missed approach collision risk for ADG VI Cat I.



For specific standard, please check Table 2-2 in FAA AC 150/5300-13.

Figure AA-40. Missed approach collision risk for ADG VI Cat II.

Section 5.1.2—Landing Veer-Off Collision Risk Plots (Ground Phase)

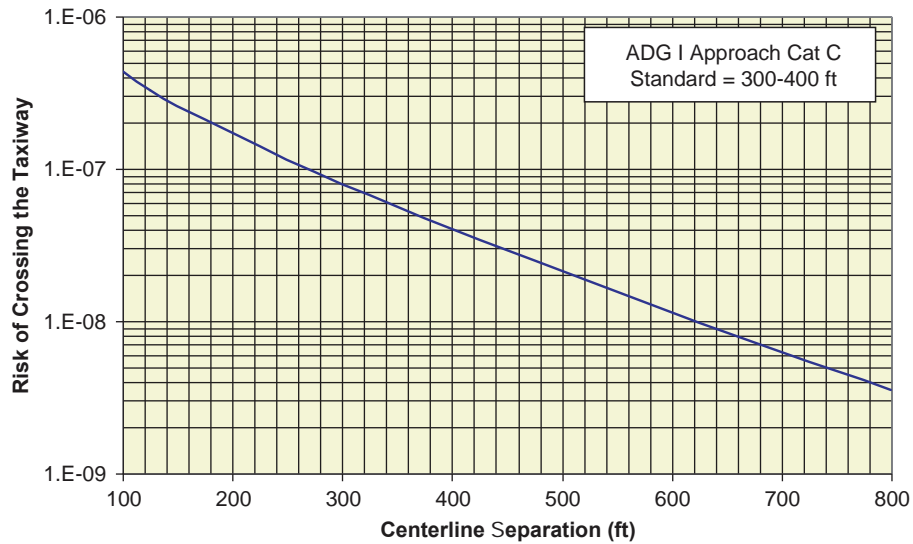

Figure AA-41. Landing veer-off collision risk for ADG I.

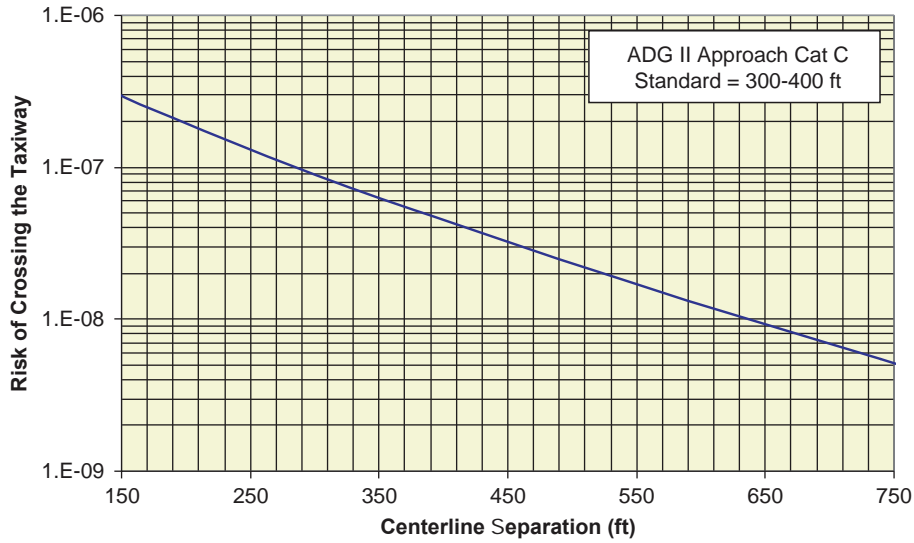

Figure AA-42. Landing veer-off collision risk for ADG II.

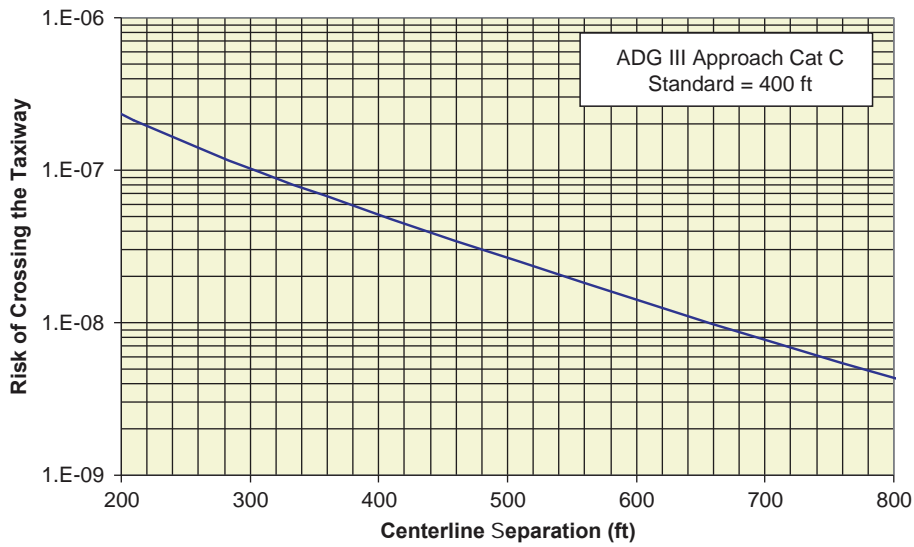

Figure AA-43. Landing veer-off collision risk for ADG III.

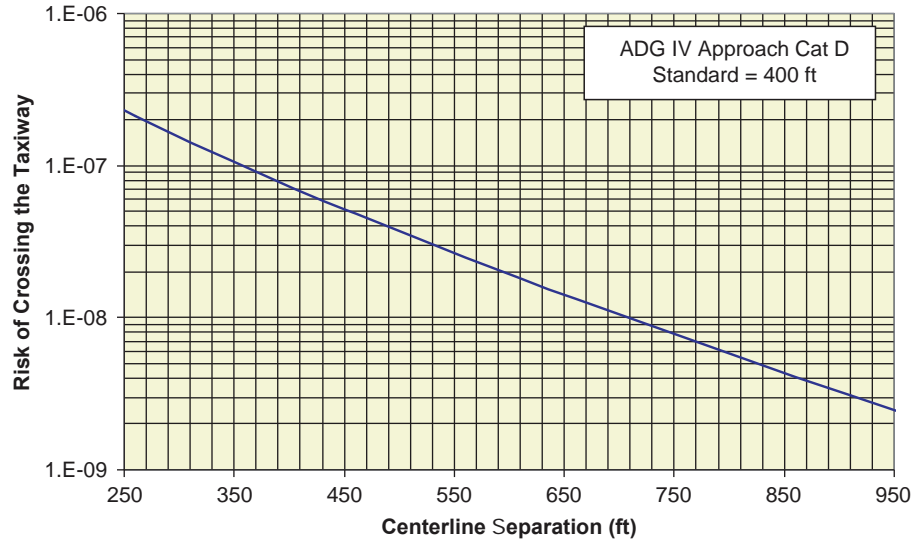
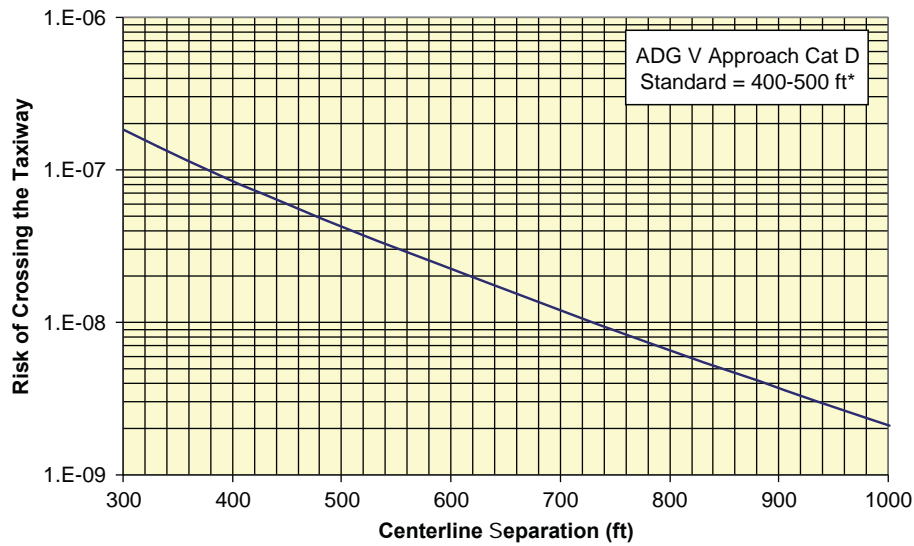
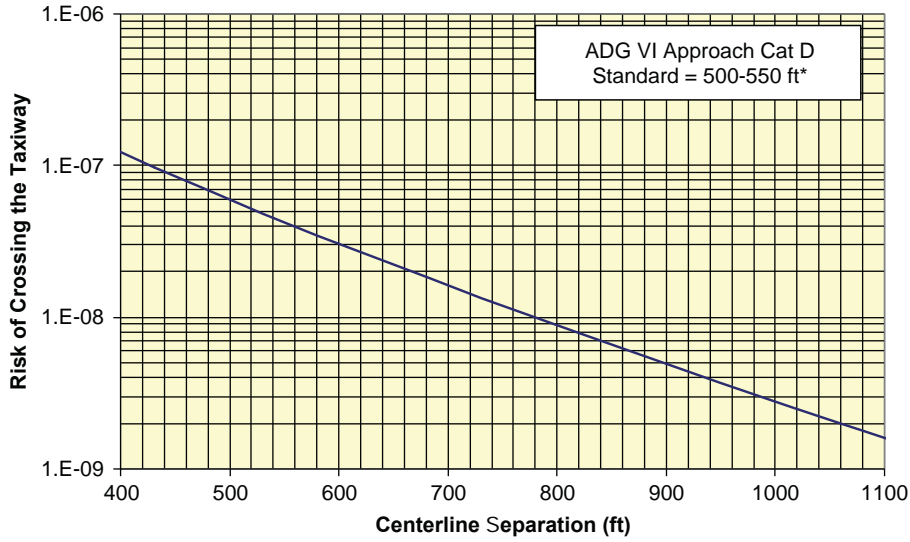

Figure AA-44. Landing veer-off collision risk for ADG IV.



For specific standard, please check Table 2-2 in FAA AC 150/5300-13.

Figure AA-45. Landing veer-off collision risk for ADG V.



For specific standard, please check Table 2-2 in FAA AC 150/5300-13.

Figure AA-46. Landing veer-off collision risk for ADG VI.

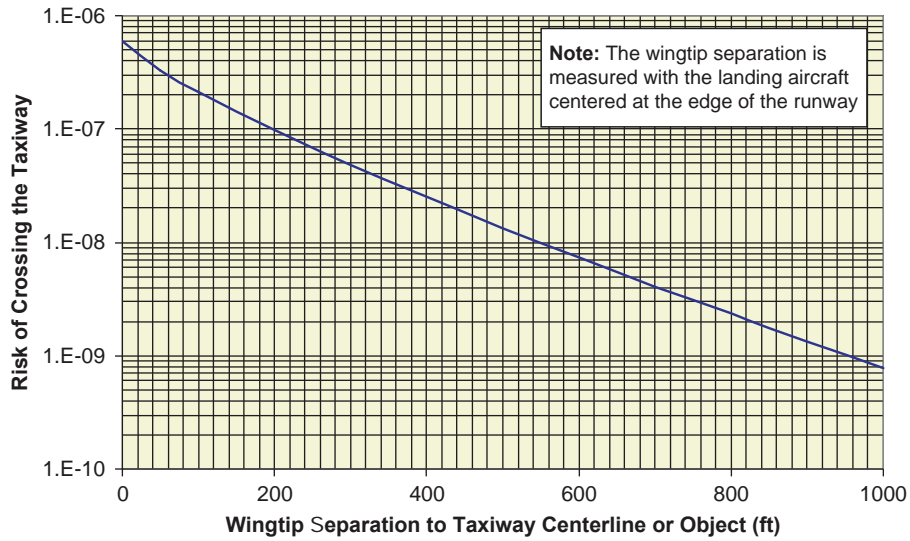

Figure AA-47. Landing veer-off collision risk based on wingtip clearance—any ADG.

Section 5.2—Takeoff Veer-Off Collision Risk Plots

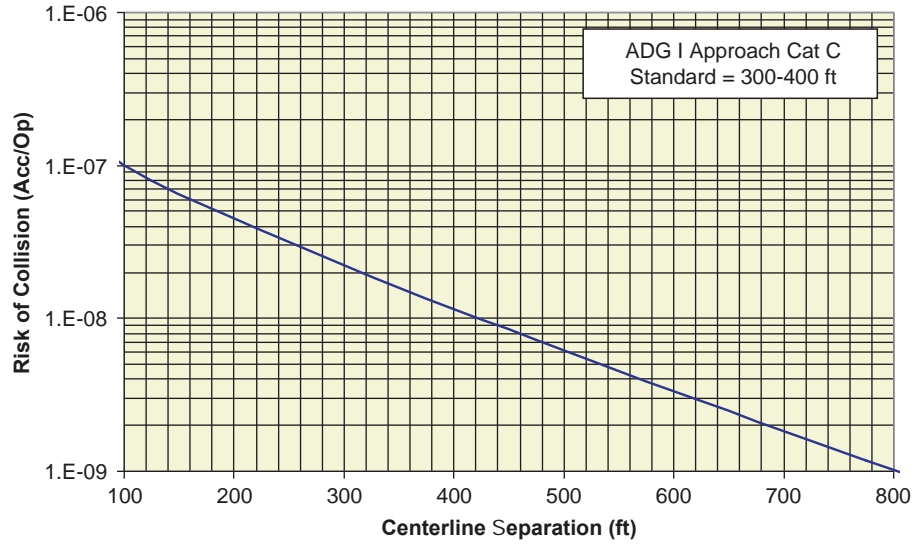

Figure AA-48. Takeoff veer-off collision risk for ADG I.

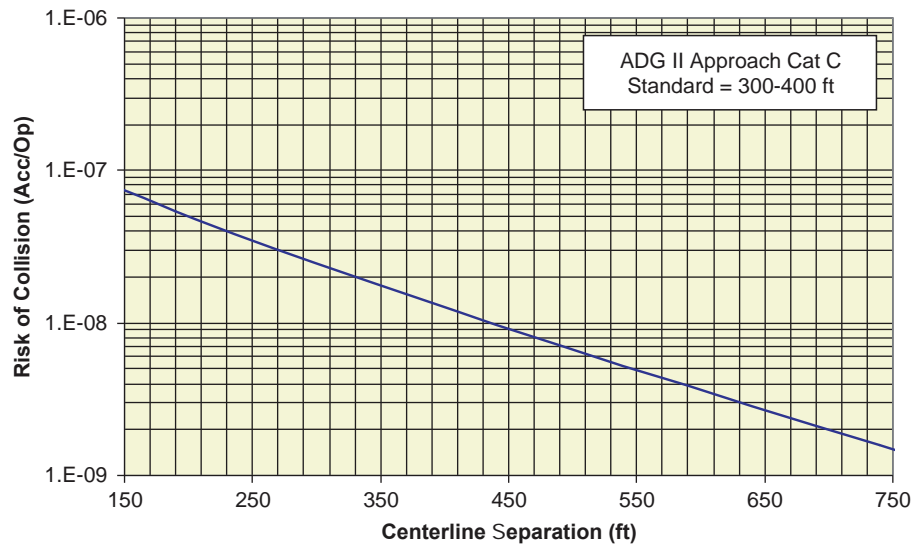

Figure AA-49. Takeoff veer-off collision risk for ADG II.

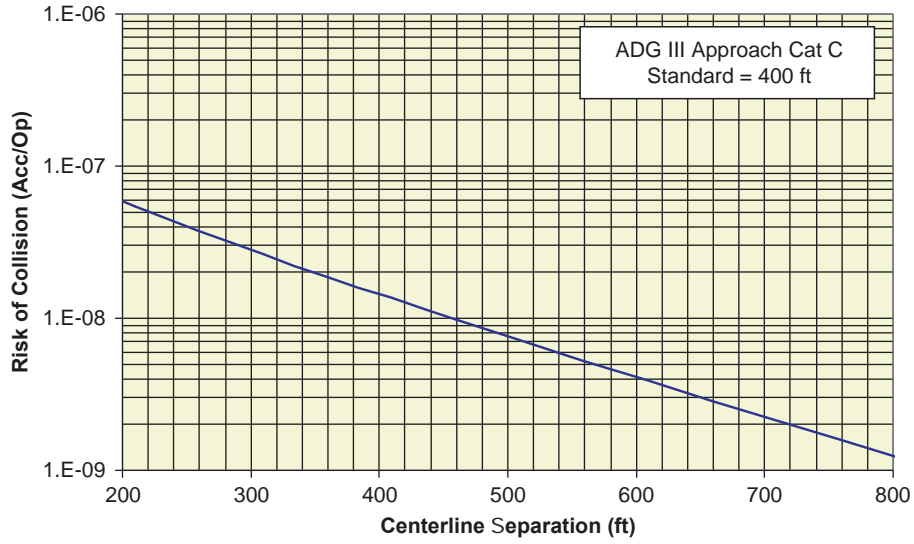

Figure AA-50. Takeoff veer-off collision risk for ADG III.

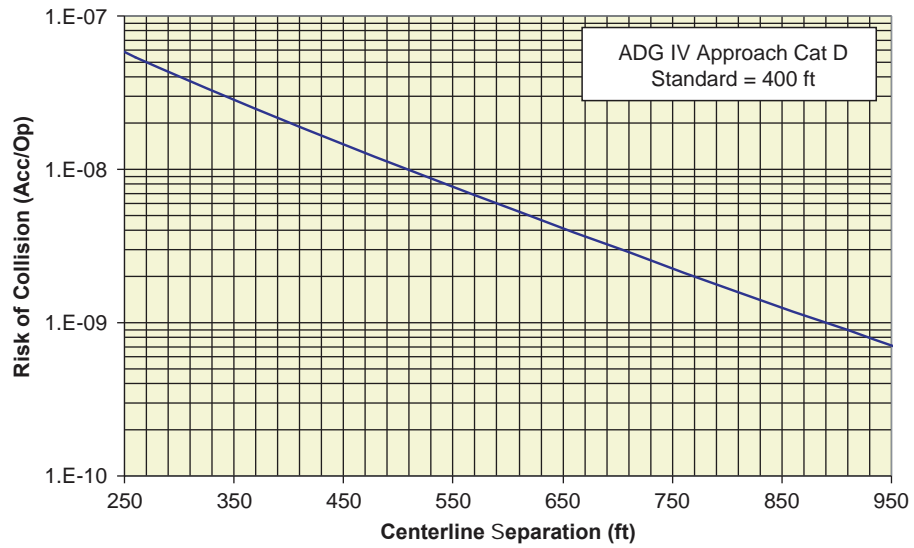

Figure AA-51. Takeoff veer-off collision risk for ADG IV.

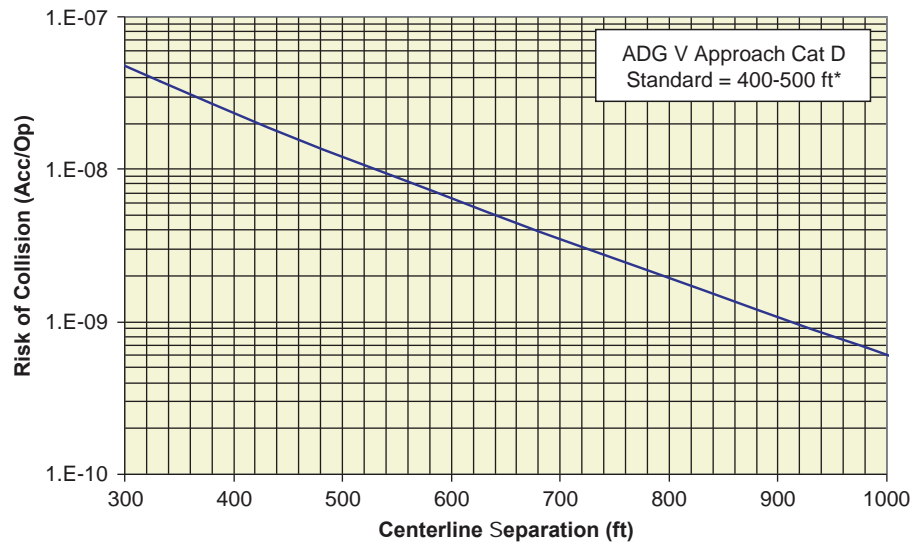

Figure AA-52. Takeoff veer-off collision risk for ADG V.

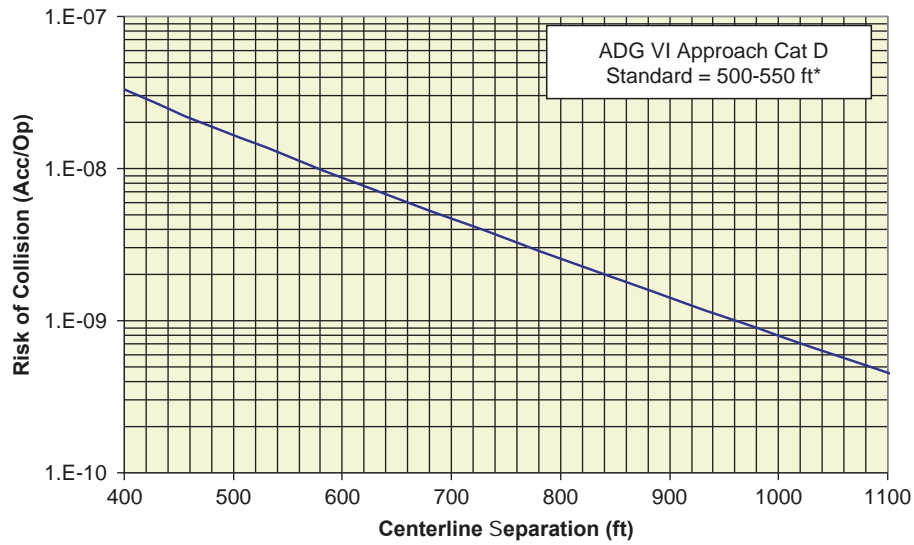

Figure AA-53. Takeoff veer-off collision risk for ADG VI.

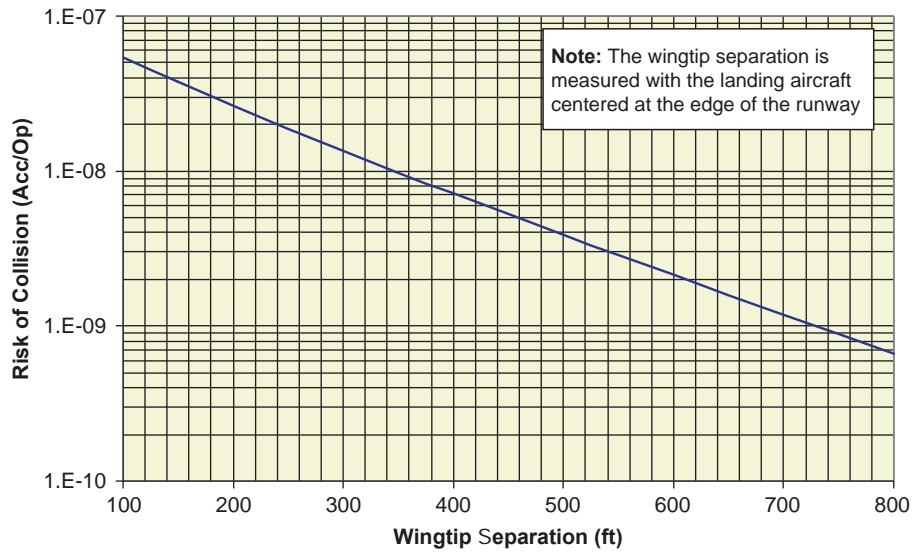

Figure AA-54. Takeoff veer-off collision risk based on wingtip clearance—any ADG.

APPENDIX B

Collision Risk Model

Appendix B of the contractor's final report is not published herein, but is available on the TRB website at <http://www.trb.org/Main/Blurbs/165180.aspx>.

APPENDIX C

Key Studies on Aircraft Deviation

Appendix C of the contractor's final report is not published herein, but is available on the TRB website at <http://www.trb.org/Main/Blurbs/165180.aspx>.

APPENDIX D

List of Veer-Off Accidents and Incidents

Appendix D of the contractor's final report is not published herein, but is available on the TRB website at <http://www.trb.org/Main/Blurbs/165180.aspx>.

APPENDIX E

Sample of Normal Operations Data

Appendix E of the contractor's final report is not published herein, but is available on the TRB website at <http://www.trb.org/Main/Blurbs/165180.aspx>.

APPENDIX F

Aircraft Database Summary

Table F-1. Summary of aircraft characteristics by model.

Aircraft Name	Manufacturer	I AO Code	in span ft	Len t ft	ei t ft	n ine Type	n ines #	MTO lb	Ta coff Distance ft	Landin Distance ft	V2 ts	Approac speed ts
Mohawk 298	Aerospatiale	N262	71.9	63.3	20.3	Turboprop	2	23,369	2,296.6	1,312.3	100	110
Aerostar 600	Aerostar	AEST	36.7	34.8	12.8	Piston	2	6,305	1,804.5	1,148.3	95	94
A-300	Airbus	A30B	147.1	177.5	54.3	Jet	2	378,534	7,349.1	5,026.2	160	135
A-300-600	Airbus	A306	147.1	177.5	54.3	Jet	2	378,534	7,349.1	5,026.2	160	135
A-310-200/300	Airbus	A310	144.0	153.1	51.8	Jet	2	330,693	7,513.1	4,888.5	160	135
A-318	Airbus	A318	111.9	103.2	41.2	Jet	2	130,073	4,593.2	4,265.1	135	138
A-319	Airbus	A319	111.9	111.2	38.6	Jet	2	141,096	5,741.5	4,429.1	135	138
A-320	Airbus	A320	111.9	123.3	38.6	Jet	2	162,040	7,185.0	4,724.4	145	138
A-321	Airbus	A321	111.9	146.0	38.6	Jet	2	182,984	7,250.7	5,249.3	145	138
A-330-200	Airbus	A332	197.8	192.9	57.1	Jet	2	507,063	7,545.9	5,905.5	145	140
A-330-300	Airbus	A333	197.8	208.7	55.3	Jet	2	507,063	7,545.9	5,905.5	145	130
A-340-200	Airbus	A342	197.8	194.8	54.8	Jet	4	606,271	9,071.5	5,790.7	145	150
A-340-300	Airbus	A343	197.8	208.7	55.3	Jet	4	606,271	9,071.5	6,003.9	145	150
A-340-500	Airbus	A345	208.2	222.8	56.1	Jet	4	811,301	10,498.7	6,299.2	145	150
A-340-600	Airbus	A346	208.2	247.0	56.8	Jet	4	811,301	10,301.8	6,561.7	145	150
A-380-800	Airbus	A388	261.8	239.5	79.1	Jet	4	1,234,589	9,744.1	6,594.5	150	145
Alenia ATR-42-200/300	ATR	AT43	80.7	74.5	24.9	Turboprop	2	36,817	3,608.9	3,280.8	110	104
Alenia ATR-72-200/210	ATR	AT72	88.9	89.2	25.3	Turboprop	2	47,399	4,921.3	3,608.9	110	105
Avro 748	Avro	A748	98.2	66.9	24.9	Turboprop	2	46,495	3,280.8	2,034.1	110	100
Jetstream 31	Bae Systems	JS31	52.0	47.1	17.5	Turboprop	2	15,562	5,905.5	4,265.1	110	125
Jetstream 32	Bae Systems	JS32	52.0	47.1	17.7	Turboprop	2	16,226	5,150.9	4,002.6	110	125
Jetstream 41	Bae Systems	JS41	60.4	63.4	18.4	Turboprop	2	24,000	4,921.3	4,265.1	110	120
100 ing Air	Beech	BE10	45.9	40.0	15.4	Turboprop	2	11,795	1,476.4	2,132.5	105	111
33 Debonair	Beech	BE33	33.5	25.6	8.2	Piston	1	3,064	1,148.3	984.3	75	70
Beech 55 Baron	Beech	BE55	37.7	27.9	9.5	Piston	2	5,071	1,476.4	1,476.4	95	90
Beech 60 Duke	Beech	BE60	39.4	33.8	12.5	Piston	2	6,768	1,968.5	1,312.3	95	98
Beech 76 Duchess	Beech	BE76	38.1	29.2	9.5	Piston	2	3,902	2,132.5	1,968.5	85	76
Beech 99 Airliner	Beech	BE99	45.9	44.6	14.4	Turboprop	2	16,755	3,280.8	2,952.8	115	107
Bonanza V35B	Beech	BE35	33.4	26.3	7.6	Piston	1	3,400	1,150.0	1,480	70	70
ing Air F90	Beech	BE9T	45.9	39.8		Turboprop	2	10,950				108

Table F-1. (Continued).

Aircraft Name	Manufacturer	IAO Code	in span ft	Len t ft	ei t ft	n ine Type	n ines #	MTO lb	Ta coff Distance ft	Landin Distance ft	V2 ts	Approac speed ts
Super ing Air 300	Beech	BE30	54.5	44.0	14.8	Turboprop	2	13,889	1,870.1	1,771.7	115	103
Premier 1A	Beechcraft	PRM1	44.5	46.0	15.3	Jet	2	12,500	3,792.0	3,170.0		121
B707-100	Boeing	B701	130.9	144.7	42.3	Jet	4	190,003	8,694.2	6,496.1		139
B717-200	Boeing	B712	93.2	124.0	29.5	Jet	2	120,999	6,889.8	5,249.3	130	139
B727 Stage 3 Noise Acft	Boeing	B727	107.9	153.2	34.1	Jet	3	210,101	9,842.5	4,921.3	145	150
B727-100	Boeing	B721	108.0	133.2	34.3	Jet	3	169,095	8,202.1	4,921.3		125
B727-200	Boeing	B722	107.9	153.2	34.1	Jet	3	210,101	9,842.5	4,921.3	145	150
B737 Stage 3 Noise Acft	Boeing	B737	93.0	94.0	37.2	Jet	2	110,121	5,905.5	4,593.2	145	137
B737-100	Boeing	B731	93.0	94.0	37.2	Jet	2	110,121	5,905.5	4,593.2	145	137
B737-200	Boeing	B732	93.0	100.2	37.2	Jet	2	115,500	6,003.9	4,593.2	145	137
B737-300	Boeing	B733	94.8	109.6	36.6	Jet	2	124,495	5,249.3	4,593.2	140	135
B737-400	Boeing	B734	94.8	119.4	36.6	Jet	2	138,494	6,561.7	4,921.3	150	139
B737-500	Boeing	B735	94.8	101.7	36.6	Jet	2	115,500	4,921.3	4,593.2	139	140
B737-600	Boeing	B736	112.6	102.5	40.8	Jet	2	123,988	6,233.6	4,265.1	135	125
B737-700	Boeing	B737	112.6	110.3	40.8	Jet	2	146,211	5,905.5	4,593.2	140	130
B737-800	Boeing	B738	112.6	129.5	40.6	Jet	2	155,492	7,545.9	5,249.3	145	141
B737-900	Boeing	B739	112.6	138.2	40.6	Jet	2	174,198	7,545.9	5,577.4	149	144
B747-100	Boeing	B741	195.3	229.0	64.2	Jet	4	735,021	10,465.9	6,233.6	170	152
B747-200	Boeing	B742	195.7	229.0	64.2	Jet	4	826,403	10,498.7	6,233.6	173	152
B747-300	Boeing	B743	195.7	229.0	64.2	Jet	4	826,403	10,826.8	7,217.8	178	160
B747-400	Boeing	B744	195.6	229.2	64.2	Jet	4	874,993	10,826.8	6,988.2	185	154
B747-400ER	Boeing	B744ER	213.0	231.9	64.3	Jet	4	910,002	10,498.7	7,841.2		157
B747-8	Boeing	B748	224.4	246.9	64.3	Jet	4	975,001	10,000.0	8,595.8		159
B757-200	Boeing	B752	124.8	155.2	45.1	Jet	2	255,031	6,233.6	4,593.2	145	135
B757-300	Boeing	B753	124.8	177.4	44.8	Jet	2	272,491	8,530.2	5,905.5	145	142
B767-200	Boeing	B762	156.1	159.2	52.9	Jet	2	395,002	8,858.3	4,921.3	160	130
B767-300	Boeing	B763	156.1	180.2	52.6	Jet	2	412,000	9,514.4	5,905.5	160	130
B767-400	Boeing	B764	170.3	201.3	55.8	Jet	2	449,999	9,514.4	5,905.5	160	150
B767-400ER	Boeing	B764ER	170.3	201.3	55.8	Jet	2	449,999	9,514.4	5,905.5	160	150
B777-200	Boeing	B772	199.9	209.1	61.5	Jet	2	545,005	9,514.4	5,577.4	170	145
B777-200LR	Boeing	B772LR	212.6	209.1	61.5	Jet	2	766,001	9,514.4	5,577.4	170	139
B777-300	Boeing	B773	199.9	242.3	61.5	Jet	2	659,998	9,842.5	5,905.5	168	145

(continued on next page)

Table F-1. (Continued).

Aircraft Name	Manufacturer	I AO Code	in span ft	Len t ft	ei t ft	n ine Type	n ines #	MTO lb	Ta off Distance ft	Landin Distance ft	V2 ts	Approac speed ts
B777-300ER	Boeing	B773ER	212.6	242.3	61.8	Jet	2	775,002	9,514.4	5,905.5	160	145
B787-8 Dreamliner	Boeing	B788	197.2	186.1	55.5	Jet	2	484,001				140
BMD-90	Boeing	MD90	107.8	152.6	31.2	Jet	2	164,244	7,217.8	3,937.0	140	140
BD-700 Global Express	Bombardier	GLEX	93.8	99.4	24.9	Jet	2	98,106	6,135.2	1,358.3	120	126
BAC 1-11	British Aerospace	BA11	93.5	107.0	25.4	Jet	2	99,651	7,470.5	4,757.2	140	129
BAE-146-200	British Aerospace	B462	86.4	93.7	28.2	Jet	4	93,035	3,379.3	4,051.8	125	125
CL-600 Challenger	Canadair	CL60	61.8	68.4		Jet	2	47,600				125
RJ-100 Regional Jet	Canadair	CRJ1	69.6	87.9	20.7	Jet	2	47,399	5,249.3	4,593.2	135	135
RJ-200 Regional Jet	Canadair	CRJ2	69.6	87.9	20.7	Jet	2	47,399	5,249.3	4,593.2	135	135
RJ-700 Regional Jet	Canadair	CRJ7	76.2	106.7	24.8	Jet	2	72,753	5,249.3	4,849.1	135	135
RJ-900 Regional Jet	Canadair	CRJ9	76.4	118.8	24.6	Jet	2	80,491	6,168.0	5,118.1	170	150
Aviocar	Casa	C212	66.6	53.1	21.7	Turboprop	2	16,976	2,952.8	1,640.4	100	81
500 Citation	Cessna	C500	47.2	43.6	14.4	Jet	2	10,847	3,274.3	1,870.1	120	125
Cessna 120	Cessna	C120	32.8	21.0		Piston	1	1,450	650.0	460.0		
Cessna 150 Commuter	Cessna	C150	33.5	21.7	6.9	Piston	1	1,499	820.2	656.2	55	55
Cessna 172 Skyhawk	Cessna	C172	35.8	26.9	8.9	Piston	1	2,315	984.3	524.9	60	65
Cessna 182 Skylane	Cessna	C182	36.1	28.2	9.2	Piston	1	2,800	656.2	1,348.4	65	92
Cessna 185 Skywagon	Cessna	C185	36.2	25.8	7.8	Piston	1	3,351	650.0	610.0		
Cessna 206 Caravan 1	Cessna	C208	52.2	37.7	14.1	Turboprop	1	8,001	1,640.4	1,476.4	85	104
Cessna 210 Centurion	Cessna	C210	36.7	28.2	9.8	Piston	1	4,012	1,312.3	1,476.4	70	75
Cessna 340 Rocket	Cessna	C340	38.1	34.4	12.5	Piston	2	5,975	2,132.5	1,640.4	95	110
Cessna 402 Utililiner	Cessna	C402	44.2	36.4	11.8	Piston	2	6,305	2,221.1	1,765.1	95	95
Cessna 404 Titan	Cessna	C404	49.5	39.0	13.1	Piston	2	8,444	2,296.6	1,968.5	100	100
Cessna 414 Chancellor	Cessna	C414	41.0	33.8	11.8	Piston	2	6,746	1,706.0	2,296.6	100	94
Cessna 421 Golden Eagle	Cessna	C421	40.0	33.8	11.8	Piston	2	6,834	1,968.5	2,460.6	100	96
Cessna 425 Corsair	Cessna	C425	44.3	35.8	12.8	Turboprop	2	8,598	2,460.6	2,132.5	105	110
Cessna 441 Conquest	Cessna	C441	49.3	39.0	13.1	Turboprop	2	9,855	1,804.5	1,148.3	105	100
Cessna 500 Citation 1	Cessna	C500	47.2	43.6	14.4	Jet	2	10,847	3,274.3	1,870.1	120	108
Cessna 501 Citation 1SP	Cessna	C501	47.2	43.6	14.4	Jet	2	10,847	3,274.3	1,870.1	120	125
Cessna 525 Citation CJI	Cessna	C525	46.9	42.7	13.8	Jet	2	10,399	3,080.7	2,749.3	115	107
Cessna 550 Citation 2	Cessna	C550	52.2	47.2	15.1	Jet	2	15,102	3,280.8	3,002.0	115	108

Table F-1. (Continued).

Aircraft Name	Manufacturer	I A O ode	in span ft	Len t ft	ei t ft	n ine Type	n ines #	MTO lb	Ta coff Distance ft	Landin Distance ft	V2 ts	Approac peed ts
Cessna 560 Citation 5 Ultra	Cessna	C560	45.3	48.9	13.8	Jet	2	15,895	3,159.4	2,919.9	105	108
Cessna 650 Citation 3	Cessna	C650	53.5	55.4	16.8	Jet	2	30,997	5,249.3	2,952.8	125	114
Cessna 750 Citation 10	Cessna	C750	64.0	72.2	19.0	Jet	2	35,699	5,708.7	3,818.9	125	130
Cessna Stationair 6	Cessna	C206	35.8	28.2	9.8	Piston	1	3,638	820.2	1,476.4	75	92
Cessna T303 Crusader	Cessna	C303	39.0	30.5	13.5	Piston	2	5,159	1,748.7	1,460.0	85	110
Cessna T310	Cessna	C310	37.1	31.8	10.8	Piston	2	5,498	1,663.4	1,791.3	95	110
Citation CJ2	Cessna	C25A	49.5	46.9	13.8	Jet	2	12,375	3,418.6	2,985.6	115	118
Citation CJ3	Cessna	C25B	49.5	46.9	13.8	Jet	2	12,375	3,418.6	2,985.6	115	118
Citation Excel	Cessna	C56X	55.8	51.8	17.1	Jet	2	19,200	3,461.3	2,919.9	115	125
Falcon 10	Dassault	FA10	42.9	45.5		Jet	2	18,739				104
Falcon 200	Dassault	FA20	53.5	56.4	17.4	Jet	2	29,013	5,249.3	3,608.9	120	107
Falcon 2000	Dassault	F2TH	63.3	66.3	23.3	Jet	2	35,803	5,249.3	5,249.3	120	114
Falcon 50	Dassault	FA50	61.9	60.8	29.4	Jet	3	38,801	4,593.2	3,608.9	120	113
Falcon 900	Dassault	F900	63.3	66.3	24.9	Jet	3	46,738	4,921.3	2,296.6	125	100
DHC-5 Buffalo	De Havilland Canada	DHC5	65.0	49.5	19.4	Turboprop	2	12,500	1,640.4	984.3	80	77
DHC-7 Dash 7	De Havilland Canada	DHC7	93.2	80.7	26.2	Turboprop	4	47,003	2,952.8	3,280.8	90	83
DHC-8-100 Dash 8	De Havilland Canada	DH8A	85.0	73.2	24.6	Turboprop	2	34,502	2,952.8	2,952.8	100	100
DHC-8-300 Dash 8	De Havilland Canada	DH8C	89.9	84.3	24.6	Turboprop	2	41,099	3,608.9	3,280.8	110	90
DHC-8-400 Dash 8	De Havilland Canada	DH8D	93.2	107.6	27.2	Turboprop	2	63,930	4,265.1	3,608.9	115	115
DC-8 Stage 3 Noise Aircraft	Douglas	DC8	142.4	150.6	42.3	Jet	4	324,961	9,842.5	6,561.7	130	137
DC-8-50	Douglas	DC85	142.4	150.6	42.3	Jet	4	324,961	9,842.5	6,561.7	130	137
DC-8-60	Douglas	DC86	142.4	187.3	42.3	Jet	4	349,874	9,842.5	6,561.7	130	137
DC-8-70	Douglas	DC87	148.3	187.3	43.0	Jet	4	357,204	10,006.6	6,561.7	160	150
DC-9-10	Douglas	DC91	89.6	119.4	27.5	Jet	2	110,099	6,889.8	4,921.3	140	127
DC-9-30	Douglas	DC93	89.6	119.4	27.6	Jet	2	110,099	6,889.8	4,921.3	140	127
DC-9-40	Douglas	DC94	93.5	133.5	28.0	Jet	2	121,109	6,889.8	4,921.3	140	130
DC-9-50	Douglas	DC95	93.5	133.5	27.9	Jet	2	121,109	6,889.8	4,921.3	140	132
DC-9-50	Douglas	DC95	93.5	133.5	27.9	Jet	2	121,109	6,889.8	4,921.3	140	132

(continued on next page)

Table F-1. (Continued).

Aircraft Name	Manufacturer	I AO Code	in span ft	Len t ft	ei t ft	n ine Type	n ines #	MTO lb	Ta coff Distance ft	Landin Distance ft	V2 ts	Approac speed ts
EMB-110 Bandeirante	Embraer	E110	50.2	46.6	16.1	Turboprop	2	13,007	3,937.0	4,265.1	90	92
EMB-120 Brasilia	Embraer	E120	65.0	65.6	21.0	Turboprop	2	26,455	4,593.2	4,593.2	120	120
EMB-145	Embraer	E145	65.7	98.0	22.2	Jet	2	46,734	6,561.7	4,429.1	130	135
EMB-145XR	Embraer	E45X	68.9	98.0	22.2	Jet	2	46,734	6,561.7	4,429.1	130	135
Embraer 140	Embraer	E140	65.7	93.3	22.1	Jet	2	46,518	6,069.6	4,527.6	130	135
Embraer 175	Embraer	E175	85.3	103.9	31.9	Jet	2	82,673	7,362.2	4,137.1	140	145
Embraer 195	Embraer	E195	94.2	126.8	34.6	Jet	2	107,564	7,149.0	4,206.0	140	145
ERJ-135	Embraer	E135	65.7	86.4	22.2	Jet	2	44,070	5,774.3	4,461.9	125	130
ERJ-170	Embraer	E170	85.3	98.1	32.3	Jet	2	79,344	5,393.7	4,176.5	140	145
ERJ-190	Embraer	E190	94.2	118.9	34.7	Jet	2	105,359	6,745.4	4,340.6	140	145
328 Jet Envoy 3	Fairchild-Dornier	J328	68.8	69.9	23.6	Jet	2	33,510	4,265.1	3,937.0	135	120
Fairchild-Dornier 328	Fairchild-Dornier	D328	68.8	69.3	23.9	Turboprop	2	30,843	3,280.8	3,937.0	110	110
F-27 Friendship	Fokker	F27	95.1	75.8	27.9	Turboprop	2	44,996	2,296.6	1,968.5	100	120
F-28 Fellowship	Fokker	F28	88.8	89.9	27.9	Jet	2	72,995	5,577.4	3,280.8	135	125
Fokker 100	Fokker	F100	92.2	116.5	27.9	Jet	2	95,659	5,577.4	4,593.2	135	130
Fokker 50	Fokker	F50	95.1	82.7	27.2	Turboprop	2	43,982	3,608.9	3,608.9	120	120
Fokker 70	Fokker	F70	95.5	101.4	27.9	Turboprop	2	71,981	4,265.1	3,937.0	125	120
Greyhound C2	Grunman	C2	80.7	57.7	18.4	Turboprop	2	54,426	2,608.3	1,476.4	105	105
695 JetProp Commander	Gulfstream Aerospace	AC95	52.2	43.0	15.1	Turboprop	2	11,199	1,640.4	1,640.4	100	500
980/1000	Gulfstream Aerospace	GLF2	68.1	79.1		Jet	2	65,301				141
G-1159 Gulfstream 2	Gulfstream Aerospace	GLF3	77.8	83.0	24.6	Jet	2	69,710	5,905.5	3,280.8	145	136
G-1159A Gulfstream 3	Gulfstream Aerospace	GLF4	77.8	88.3	24.3	Jet	2	73,193	5,249.3	3,280.8	145	128
G-1159C Gulfstream 4	Gulfstream Aerospace	GLF5	93.5	96.5	25.9	Jet	2	90,689	5,150.9	2,900.3	145	145
G-1159D Gulfstream 5	Gulfstream Aerospace	IL62	141.7	174.2	40.7	Jet	4	363,763	10,826.8	7,545.9	150	152
Ilyushin IL-62	Ilyushin	IL96	197.2	181.4	57.4	Jet	4	595,248	9,186.4	6,561.7	150	150
Ilyushin IL-96	Ilyushin Israel											
1124 Westwind	Aerospace Industries	WW24	44.9	52.2	15.7	Jet	2	22,928	4,839.2	2,460.6	125	129

Table F-1. (Continued).

Aircraft Name	Manufacturer	I AO code	in span ft	Len t ft	ei t ft	n ine Type	n ines #	MTO lb	Ta coff Distance ft	Landin Distance ft	V2 ts	Approac speed ts
1125 Astra	Israel Aerospace Industries	ASTR	52.8	55.4	18.0	Jet	2	24,648	5,249.3	2,952.8	130	126
1126 Galaxy	Israel Aerospace Industries	GALX	58.1	62.3	21.3	Jet	2	34,851	5,905.5	3,444.9	125	130
Learjet 24	Learjet	LJ24	35.1	43.0		Jet	2	13,001				128
Learjet 25	Learjet	LJ25	35.4	47.6	12.1	Jet	2	14,991	3,937.0	2,952.8	130	137
Learjet 31	Learjet	LJ31	43.6	48.6	12.5	Jet	2	15,498	3,608.9	2,952.8	130	120
Learjet 35	Learjet	LJ35	39.4	48.6	12.1	Jet	2	18,298	4,265.1	2,952.8	140	125
Learjet 35	Learjet	LJ35	39.4	48.6	12.1	Jet	2	18,298	4,265.1	2,952.8	140	125
Learjet 45	Learjet	LJ45	47.9	58.1	14.1	Jet	2	19,511	4,265.1	2,952.8	140	140
Learjet 55	Learjet	LJ55	43.6	55.1	14.8	Jet	2	21,010	4,593.2	3,280.8	140	140
Learjet 60	Learjet	LJ60	44.0	58.7	14.8	Jet	2	23,104	5,249.3	3,608.9	140	140
AC-130 Spectre	Lockheed	C130	132.5	97.8	38.7	Turboprop	4	155,007	3,608.9	2,624.7	120	130
Electra	Lockheed	L188	99.1	104.3	32.8	Turboprop	4	112,987	4,265.1	2,952.8	120	130
L-1011 TriStar	Lockheed	L101	155.5	178.1	55.4	Jet	3	429,990	7,874.0	5,905.5	150	138
P-3 Orion	Lockheed	P3	99.7	116.8	0.0	Turboprop	4	135,000				134
DC-10	McDonnell Douglas	DC10	165.4	180.4	58.1	Jet	3	572,009	9,842.5	5,905.5	150	136
MD-11	McDonnell Douglas	MD11	169.9	200.8	57.7	Jet	3	630,500	10,170.6	6,889.8	160	155
MD-80	McDonnell Douglas	MD80	107.8	147.7	30.2	Jet	3	149,500	6,732.3	5,200.1	140	150
MD-81	McDonnell Douglas	MD81	107.8	147.7	30.2	Jet	3	149,500	6,732.3	5,200.1	140	150
MD-82	McDonnell Douglas	MD82	107.8	147.7	30.2	Jet	3	149,500	6,732.3	5,200.1	140	150
MD-83	McDonnell Douglas	MD83	107.8	147.7	30.2	Jet	3	160,001	6,732.3	5,200.1	140	150
MD-88	McDonnell Douglas	MD88	107.8	147.7	30.2	Jet	3	149,500	6,732.3	5,200.1	140	150
LR-1 Marquise	Mitsubishi	MU2	39.0	33.1	12.8	Turboprop	2	10,053	2,132.5	1,968.5	120	88
Aerostar 200	Mooney	M20P	35.1	23.3	8.2	Piston	1	2,579	1,476.4	820.2	70	70
Observer	Partenavia	P68	39.4	30.8	11.2	Piston	2	4,586	1,312.3	1,968.5	75	73
P-180 Avanti	Piaggio	P180	45.9	47.2	12.8	Turboprop	2	11,552	2,952.8	2,952.8	120	120

(continued on next page)

Table F-1. (Continued).

Aircraft Name	Manufacturer	I AO Code	in span ft	Len t ft	ei t ft	n ine Type	n ines #	MTO lb	Ta off Distance ft	Landin Distance ft	V2 ts	Approac speed ts
Astra	Pilatus	PC7	34.1	32.2	10.5	Turboprop	1	6,393	984.3	1,312.3	90	90
Eagle	Pilatus	PC12	53.1	47.2	14.1	Turboprop	1	9,921	1,968.5	1,804.5	110	85
Apache	Piper	PA23	37.0	27.1	10.3	Piston	2	4,799				
Arrow 4	Piper	P28T	35.4	27.2	8.2	Piston	1	2,910	1,148.3	656.2	70	70
Aztec	Piper	PA27	37.4	31.2	10.2	Piston	2	5,203	984.3	1,640.4	75	70
Cherokee Lance	Piper	P32R	36.1	28.2	8.5	Piston	1	3,616	1,640.4	1,804.5	75	75
Cherokee Six	Piper	PA32	36.1	26.9	8.2	Piston	1	3,616	1,640.4	1,804.5	75	75
Cheyenne 2	Piper	PAY2	42.7	36.4	12.8	Turboprop	2	8,995	2,132.5	2,460.6	100	100
Cheyenne 3	Piper	PAY3	47.6	43.3	14.8	Turboprop	2	11,244	2,296.6	2,132.5	105	105
Cheyenne 400	Piper	PAY4	47.6	43.3	17.1	Turboprop	2	12,059	2,296.6	2,132.5	125	110
Comanche	Piper	PA24	36.0	24.1	7.5	Piston	1	2,551				
Malibu Meridian	Piper	P46T	43.0	29.5	11.5	Turboprop	1	4,740	1,476.4	1,476.4	80	75
Malibu Mirage	Piper	PA46	43.0	28.5	11.5	Piston	1	4,299	1,476.4	1,476.4	80	75
Navajo Chieftain	Piper	PA31	40.7	32.5	13.1	Piston	2	6,504	1,312.3	1,968.5	90	100
PA-28-140 Cherokee	Piper	P28A	35.1	24.0	7.2	Piston	1	2,425	984.3	984.3	65	65
PA-28R Cherokee Arrow	Piper	P28R	29.9	24.3	7.9	Piston	1	2,491	984.3	984.3	70	70
Seminole	Piper	PA44	38.7	27.6	8.5	Piston	2	3,792	984.3	1,312.3	75	80
Seneca	Piper	PA34	39.0	28.5	9.8	Piston	2	4,762	984.3	1,312.3	80	80
Tomahawk	Piper	PA38	35.1	23.0	9.2	Piston	1	1,676	820.2	656.2	60	65
Twin Comanche	Piper	PA30	36.0	25.0	8.3	Piston	2	3,600				
400 Beechjet	Raytheon	BE40	43.6	48.6	13.8	Jet	2	16,094	3,937.0	3,608.9	130	111
90 ing Air	Raytheon	BE9L	50.2	35.4	14.1	Turboprop	2	10,099	2,296.6	1,246.7	100	100
Bae 125-1000	Raytheon	H25C	51.5	53.8	17.1	Jet	2	30,997	6,233.6	2,916.7	125	132
Bae 125-700/800	Raytheon	H25B	54.5	51.2	18.0	Jet	2	27,403	5,377.4	2,952.8	125	125
Beech 1900	Raytheon	B190	58.1	57.7	15.4	Turboprop	2	16,954	3,773.0	2,706.7	110	113
Beech 36 Bonanza	Raytheon	BE36	27.6	26.6	8.5	Piston	1	3,638	1,148.3	1,476.4	75	75
Beech 58 Baron	Raytheon	BE58	37.7	29.9	9.7	Piston	2	5,512	2,296.6	1,968.5	100	96
Super ing Air 200	Raytheon	BE20	54.5	44.0	14.8	Turboprop	2	12,500	1,870.1	1,771.7	115	103
Super ing Air 350	Raytheon	B350	58.1	46.6	14.4	Turboprop	2	14,991	3,280.8	2,690.3	120	110
Aero Commander 500	Rockwell International	AC50	48.9	36.7	15.1	Piston	2	6,746	1,312.3	1,312.3	80	97
Sabreliner 60	Rockwell International	SBR1	44.5	48.3		Jet	2	20,000				120

Table F-1. (Continued).

Aircraft Name	Manufacturer	I AO code	in span ft	Len t ft	ei t ft	n ine Type	n ines #	MTO lb	Ta coff Distance ft	Landin Distance ft	V2 ts	Approac speed ts
Turbo Commander 680	Rockwell International	AC80	46.8	44.5		Turboprop	2	11,199				97
Turbo Commander 690	Rockwell International	AC90	46.7	44.4	15.0	Turboprop	2	10,251				97
SAAB 2000	SAAB	SB20	81.4	89.6	25.3	Turboprop	2	46,297	4,265.1	4,265.1	110	110
SAAB 340	SAAB	SF34	70.2	64.6	23.0	Turboprop	2	28,440	4,265.1	3,608.9	110	115
C-23 Sherpa	Short	SH33	74.8	58.1	16.4	Turboprop	2	22,597	3,608.9	3,608.9	100	96
SD3-60	Short	SH36	74.8	70.9	24.0	Turboprop	2	27,117	4,265.1	3,608.9	110	100
Short SC-7 Skyvan	Short	SC7	65.0	40.0	15.1	Turboprop	2	13,669	1,968.5	2,296.6	90	90
Fairchild 300	Swearingen	SW3	46.3	42.3	16.7	Turboprop	2	12,566	4,265.1	4,265.1	115	120
Socata TBM-700	TBM	TBM7	40.0	34.1	13.8	Turboprop	1	6,614	2,132.5	1,640.4	85	80

Cells that are blank indicate that no data were available in the databases investigated.

APPENDIX G

Summary of FAA/Boeing Taxiway Deviation Studies

Appendix G of the contractor's final report is not published herein, but is available on the TRB website at <http://www.trb.org/Main/Blurbs/165180.aspx>.

APPENDIX H

Analysis of MOS Cases

This section summarizes the information collected in the MOS survey and presents results for application of the methodology described in Appendix A to each MOS case. Table H-1 shows the airports included in the MOS survey.

Table 1 Airports included in MO sur ey

ase #	Airport	ID	NPIA	MO Type	FAA Re ion
1	Philadelphia, PA	PHL	LH	TWY/TWY	AEA
2	Anchorage, A	ANC	MH	TWY/OBJ	AAL
3	Addison, TX	ADS	RL	RWY/TWY	ASW
4	Bridgeport, CT	BDR	GA	RWY/TWY	ANE
5	Accomack, VA	MFV	GA	RWY/OBJ	AEA
6	Lincoln Park, NJ	N07	RL	TLN/OBJ	AEA
7	New York JF , NY	JF	LH	TWY/TWY	AEA
8	Newark, NJ	EWR	LH	TWY/TWY*	AEA
9	Minneapolis, MN	MSP	LH	TWY/TWY	AGL
10	Chicago, IL	ORD	LH	TWY/TWY	AGL
11	Chicago, IL	ORD	LH	TWY/OBJ	AGL
12	Barnstable, MA	HYA	NH	RWY/TWY	ANE
13	Laconia, NH	LCI	GA	RWY/TWY	ANE
14	Seattle-Tacoma, WA	SEA	LH	RWY/TWY	ANM
15	Seattle-Tacoma, WA	SEA	LH	TWY/TWY	ANM
16	Aspen, CO	ASE	NH	RWY/OBJ	ANM
17	Nantucket, MA	AC	NH	TWY/TWY	ANE
18	New Castle, DE	ILG	GA	TWY/TWY	AEA
19	Leesburg, VA	JYO	RL	RWY/OBJ	AEA
20	Taunton, MA	TAN	GA	RWY/TWY	ANE

Table H-2 summarizes the cases by type of MOS; the majority of the cases were MOS for runway/taxiway separation and taxiway/taxiway separation.

Table 2 Number of cases for eac MO type

MO Type	Airport	Number of ases
Runway/Taxiway	ADS, ASE, BDR, HYA, LCI, SEA, TAN	7
Taxiway/Taxiway	AC , EWR, JF , MSP, ORD, PHL	6
Runway/Object	JYO, MFV	2
Taxiway/Taxilane	SEA	1
Taxiway/Object	ANC, ILG, N07, ORD	4
	Total	20

Table H-3 summarizes the cases by type of justification used to approve the MOS by the FAA, and Table H-4 presents a summary of the restrictions imposed due to the MOS.

Table Justifications used to obtain MO approval

MO Justification	Runway Tactical	Tactical Tactical	Runway Object	Tactical Taxi lane	Tactical Object	Total
Advisory Circular acceptable level of safety	2	3	1	1	2	9
Airport facilities capacity	2	2	1	1	2	8
Communications					1	1
Delays/Congestion		2				2
Economic constraints	2		1	1	1	5
Environmental constraints	2		1		1	4
Operations capacity		3	1	1		5
Prior ADG standards compliance	2				1	3
Physical constraints	5	4	1	1	2	13
Runway/Taxiway separation		1				1
Security					1	1

Each MOS may have more than one justification

Table Number of cases for each MO restriction by MO type

MO Restriction	Runway Tactical	Tactical Tactical	Runway Object	Tactical Taxi lane	Tactical Object	Total
Aircraft exit angle			1			1
Aircraft speed				1		1
Aircraft type/ weight/wingspan	6	4	2	1	2	15
Construction requirements	1					1
Dedicated facility use	1	3				4
Exemption/order terms		1			2	3
Markings and lighting	1	1	1	1	1	5
Operations time of day		1				1
Simultaneous facility operations		1				1
Vehicle type/ dimensions					1	1

Each MOS may have more than one restriction

The methodology was applied to each of the 20 MOS cases, and the following sections provide a summary of the issues involved, as well as characterization of the airfield separations. For each case, the methodology developed in this study was applied, and a summary of results is presented.

Case Study #1 - Philadelphia International Airport (PHL)

MO Issue	Taxilane/Taxilane	Approval Date	6/7/1999
Separations	OFA	Centerline	Wingtip
Standard	423 ft	198 ft	27
Existing	330 ft	153.5 ft	23
Airport Reference	C-III and C-IV		
Critical Aircraft	Aircraft 1	Aircraft 2	
Model	Dash 8-300	Boeing 767	
ADG	III	IV	
Wingspan	90	171	
Synopsis	One of the parallel taxilanes would be designed to serve only Terminal F (Group III aircraft) while the other taxilane would be designed to serve both Terminals E and F (Group III and IV aircraft). Proposed OFA separation distance is 330 ft.		
Restrictions	Use of southernmost taxilane is permitted to Group IV (Boeing B-767) or Group III (Dash 8-300) aircraft. Use of northernmost taxilane is limited to Group III aircraft (Dash 8-300).		
Justification	Handle the high traffic volume, minimize delays. Adequate clearance when the northernmost taxilane is limited to commuter aircraft no larger than 90 ft wingspan. Restrict the use of the taxilane to aircraft with wingspans up to 90 ft.		
Accidents/Incidents	13 accidents and incidents were identified between 1982 and 2009.		

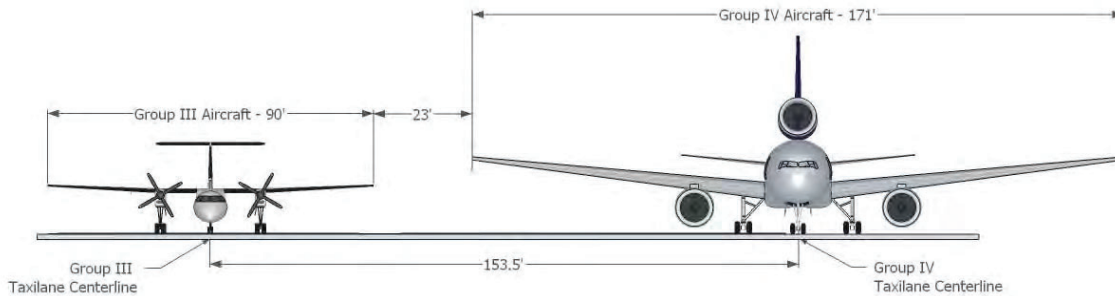

Application of Methodology

Risk Plot	Figure AA-21	Wingtip Sep	23
Severity	Major	Risk Level	1.0E-09
Conclusion	Low Risk		Acceptable

Case Study # 2 - Ted Stevens Anchorage International Airport (ANC)

MO Issue	Taxiway/Object	Approval Date	6/14/2004
Operations	OFA	Centerline	Wingtip
Standard	193 ft	193 ft	62 ft
Existing	174 ft	174 ft	43 ft
Airport Reference	D-VI		
Critical Aircraft	Aircraft 1	Aircraft 2	
Model	A-380-800	N/A	
ADG	VI		
Wingspan	262		
Synopsis	With the introduction of ADG VI (i.e., Airbus 380-800) to the airport operations, ANC proposed to reconstruct Taxiway R and widen it to 100 ft to meet the new ADG requirements. The projected taxiway width left an available taxiway OFA of 174 ft between the centerline of Taxiway R and the tug road vs. the required 193 ft OFA centerline separation based on AC 150/5300-13, Chapter 4, Table 4-1.		
Restrictions	Maintain Airbus A388 characteristics as most demanding aircraft. Handle the tug road as an operational item with Antonov 124 aircraft operations.		
Justification	Limited space availability; Cost efficiency; Security of airport operations area; Limited communication ability with tug operators; Maintain current level of cargo aircraft parking capacity. Airport already accommodates ADG VI on the existing runways and taxiways.		
Conditions for Approval	Tugs and vehicles operating on tug road between Taxiways R and T are limited to maximum height of 14 ft. Commuter simulation indicates jet blast from A388 on tug road should not be a problem. If drivers report jet blast related problems, airport authority must submit a proposed mitigation plan.		
Accidents Incidents	Nine accidents and incidents were identified between 1982 and 2009.		

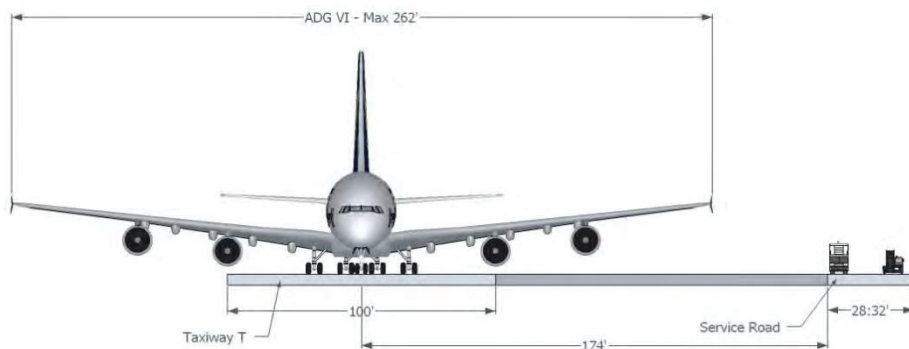

Application of Methodology

Risk Plot	AA-13	Centerline Sep	174 ft
Severity	Major	Risk Level	1.0E-09
Conclusion	Low Risk	Acceptable	

Case Study # 3 - Addison Airport (ADS)

MO Issue	Runway/Taxiway	Approval Date	11/18/2008
Separations	OFA	Centerline	Wingtip
Standard		400 ft	282 ft
Existing		300 ft	182 ft
Airport Reference	C-III		
Critical Aircraft	Aircraft 1	Aircraft 2	
Model	B-737	B-737	
ADG	III	III	
Wingspan	118	118	
Synopsis	The existing separation between Runway 15/33 and parallel Taxiway A is 300 ft, less than the required 400 ft as established in AC 150/5300-13, Chapter 2, Table 2-2 for the airport's ADG III using approach categories C and D. Relocating the parallel taxiway or the runway were not feasible options due to the limited area available to the airport for further development.		
Restrictions	Maintain B-737 characteristics as most demanding aircraft.		
Justification	Limited area available for relocating either Runway 15/33 or the parallel taxiway due to existing road and industrial developments. Airport safety will not be impeded by the proposed modification to the runway/taxiway separation.		
Conditions for Approval	None specified		
Accidents/Incidents	Two accidents and incidents were identified between 1982 and 2009.		

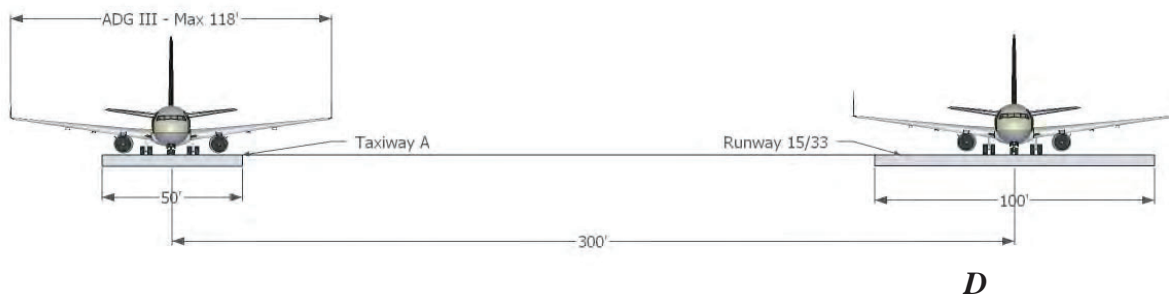

Application of Methodology

Risk Plot	AA-33 and AA-43	Centerline Sep	300 ft
Severity	Catastrophic	Risk Level Airborne	1.1E-9
		Risk Level Ground	1.0E-7
Annual Vol. Operations	133,600	Expected Years	> 140 years
Conclusion	Medium Risk	Mitigation Recommended	

Case Study # 4 - Igor I. Sikorsky Memorial Airport (BDR)

MO Issue	Runway/Taxiway	Approval Date	8/04/2003
Separations	OFA	Centerline	Wingtip
Standard		300 ft	221
Existing		268-300 ft (variable)	189-221 ft
Airport Reference	C-II		
Critical Aircraft	Aircraft 1	Aircraft 2	
Model			
ADG	II	II	
Wingspan	Max 79 ft	Max 79 ft	
synopsis	<p>The required separation between runway and taxiway at BDR is specified as 300 ft based on AC 150/5300-13, Chapter 2, Table 2-2. Locating the centerline of 35-ft-wide Taxiway D at the required distance through its length would position the end of the taxiway (i.e., toward the approach end of Runway 11) in a tidal ditch. To avoid the ditch incursion, the taxiway centerline needed to gradually decrease from the required 300 ft to 268 ft.</p> <p>Based on the wingspan dimension of the critical aircraft, it was determined that adequate clearance would remain between the end of Taxiway D and the runway Obstacle Free Zone (OFZ). In addition, no part of the critical aircraft would go beyond the 200 ft half-width OFZ limit for Runway 11/29, which is a modified width permitted for ADG II within category C per AC 150/5300-13, Chapter 3, Table 3-3 notes.</p>		
Restrictions	Runway Safety Area for aircraft Approach Category C reduced to 200 ft half-width due to ADG II as per Table 3-3 in AC 150/5300-13.		
Justification	Space limitation imposed by a deep tidal ditch. Satisfactory clearance of Runway Safety Area by ADG aircraft.		
Conditions for Approval	Location of taxiway holding position at 250 ft from runway centerline.		
Accidents Incidents	Two accidents and incidents were identified between 1982 and 2009.		

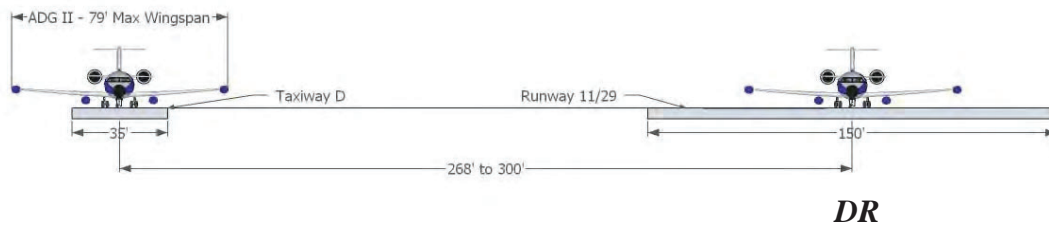

Application of Methodology

Risk Plot	Plots AA-31 and AA-42	Centerline Sep	268 ft
Severity	Catastrophic	Risk Level Airborne	1.1E-10
		Risk Level Ground	1.1E-7
Annual Vol. Operations	64,000	Expected Years	> 100 years
Conclusion	Medium Risk	Mitigation Recommended	

Case Study # 5 - Accomack County Airport (MFV)

MO Issue	Runway/Object	Approval Date	12/15/1992
Separations	OFA	Centerline	Wingtip
Standard	400 ft		
Existing	360 ft		
Airport Reference	C-II		
Critical Aircraft	Aircraft 1		Aircraft 2
Model			
ADG	II		Parked aircraft
Wingspan	Max 79 ft		Max 79 ft
Synopsis	The aircraft parking area and agricultural storage shed located near the existing terminal building had a separation distance to the runway of 360 and 400 ft, respectively. Based on AC 150/5300-13, Chapter 2, Table 2-2, the standard required runway OFA for a C-II design aircraft is 400 ft, larger than the existing separation of 360 ft between the runway and the parking area.		
Restrictions	Maintain type C-II as most demanding aircraft.		
Justification	Maintaining aircraft parking and keeping agricultural storage shed facilities operational. Adequate clearance when compared to the available distance between the runway and the terminal building of 360 ft.		
Conditions for Approval	None specified		
Accidents Incidents	No accidents and incidents were identified between 1982 and 2009.		

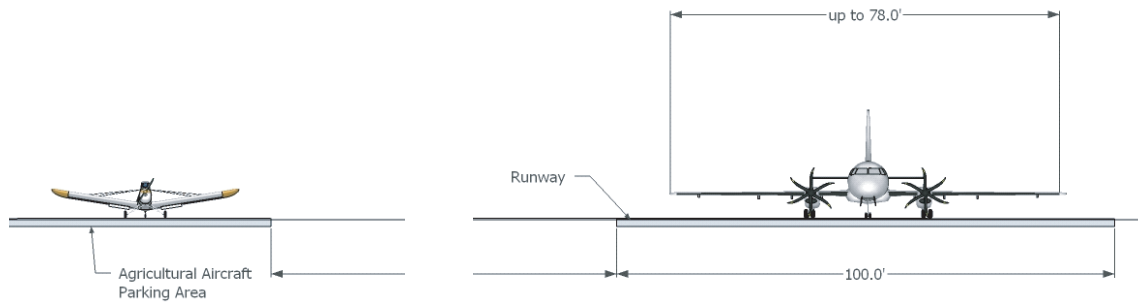

Application of Methodology

Risk Plot	Plots AA-31 and AA-42	Centerline Sep	360 ft
Severity	Catastrophic	Risk Level Airborne	1.0E-09
		Risk Level Ground	5.9E-08
Annual Vol. Operations	13,870	Expected Years	> 100 years
Conclusion	Medium Risk	Mitigation Recommended	

Case Study # 6 - Lincoln Park Airport (N07)

MO Issue	Taxilane/Object	Approval Date	4/26/2007
Operations	OFA	Centerline	Wingtip
Standard	79 ft		
Existing	75 ft		
Airport Reference	D-VI		
Critical Aircraft	Aircraft 1	Aircraft 2	
Model	Cessna 414 Chancellor	N/A	
ADG	B-I		
Wingspan	41 ft		
Synopsis	The construction of four T-hangar units near the approach end of Runway 19 reduced the taxilane OFA to 75 ft versus the required distance of 79 ft. The location of the T-hangars was constrained by the Riparian Corridor of Middle Ditch, wetlands, and Part 77 surfaces. The proposed location of the hangars was the only place that met those constraints.		
Restrictions	Taxiway and hangars should only be used by aircraft with a maximum wingspan of 42 ft.		
Justification	Hangars location within the Passaic River Basin and constrained by the Riparian Corridor of Middle Ditch, wetlands, and Part 77 surfaces. Satisfactory OFA clearance when aircraft with wingspan up to 42 ft long travels on the taxilane based on the modified equation found in AC 150/5300-13, Chapter 4, at the bottom of Table 4-1 (1.2 wingspan + 20 ft).		

Conditions for	Restrict use of taxiway to aircraft with wingspan no greater than 42 ft.
Approval	
Accidents Incidents	No accidents and incidents were identified between 1982 and 2009.

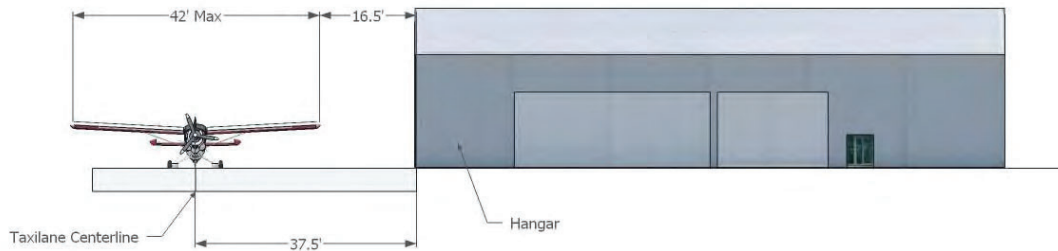

Application of Methodology

Risk Plot	Figure AA-28	Wingtip Sep	16.5 ft
Severity	Major	Risk Level	1.2E-09
Conclusion	Low Risk	Acceptable	

Case Study # 7 - John F. Kennedy International Airport (JFK)

MO Issue	Taxiway/ Taxiway	Approval Date	3/18/2008 (submitted)
Operations	OFA	Centerline	Wingtip
Standard		324 ft	
Existing		284-300 ft	
Airport Reference	D-VI		
Critical Aircraft	Aircraft 1	Aircraft 2	
Model	B747-800		B747-800
ADG	VI		VI
Wingspan	224		224
Synopsis	<p>Based on AC 150/5300-13, Chapter 2, Table 2-3, the required taxiway to taxiway centerline separation to accommodate a Boeing B747-8 (i.e., ADG VI) at JFK is 324 ft. However, the separations between some taxiways at JFK do not comply with the standards. The separation between Taxiways A and B is 284 ft, with the exception of a bridge section in which the separation is 250 ft. The separation between Taxiways P and Q, R and S, and CE and W is 300 ft. Physical space limitations at JFK make it impossible to move the existing runways and/or taxiways to obtain the standard clearances. The option of relocating runways/taxiways would have reduced the runway to taxiway separation or reduced available ramp space, which in turn would have increased ramp congestion and ultimately affected the number of available gate positions.</p>		

Restrictions	<p>Restrict simultaneous aircraft operation involving B747-800 aircraft on the bridge section of Taxiways A and B (i.e., bridge crossing the Van Wyck Expressway). Aircraft traveling north should hold on the intersection NA and aircraft traveling south will hold on the intersection with Taxiway NB.</p> <p>Restrict simultaneous aircraft operation involving B747-800 aircraft on Taxiways CA and CB, which separation is also 250 ft.</p>
Justification	<p>Limited space availability.</p> <p>Maintain current level of service without increasing ramp congestion or reducing the available ramp space.</p> <p>Based on the analysis titled <i>Statistical Extreme Value Analysis Concerning Risk of Wingtip of Fixed Object Collision for Taxiing Large Aircraft</i>, the 95% confidence interval risk of wingtip collision at JF between an Airbus A-380 and a Boeing B-747-800 on adjacent taxiways with a separation of 267 ft is as low as one in 1 billion. The existing separation between taxiways exceeds 267 ft, with the exception of a bridge section on Taxiways A and B, which separation is 250 ft.</p> <p>The calculated wingtip separation between an Airbus A-380 and a Boeing B747-800 traveling simultaneously on Taxiways A and B was 40 ft, which is greater than the standard taxiway wingtip requirement of 34 ft. Considering the case when the aircraft did not track the taxiway centerlines while taxiing, the wingtip separation was still greater than 10 ft.</p>
Accidents Incidents	15 accidents and incidents were identified between 1982 and 2009.

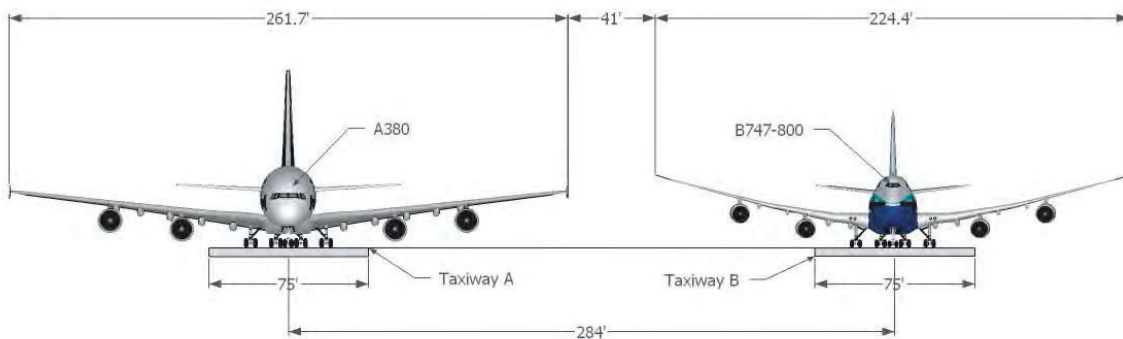

Application of Methodology

Risk Plot	AA-7	Wingtip Sep	41 ft
Severity	Major	Risk Level	1.0E-09
Conclusion	Low Risk	Acceptable	

Case Study # 8 - Newark Liberty International Airport (EWR)

MO Issue	Taxiway/ Taxiway	Approval Date	7/28/1995
Operations	OFA	Taxiway/Taxiway	Taxiway/Object
Standard	276 ft	267 ft	138 ft
Existing	260 ft	220 ft	130 ft
Airport Reference	D-V		
Critical Aircraft	Aircraft 1	Aircraft 2	
Model	B747-400ER		Any
ADG	V		Parked aircraft
Wingspan	213		Any
Synopsis	The FAA standard taxiway OFA width for ADG V is 276 ft. Chapter 2, Table 2-3, of AC 150/5300-13 allows for a modified taxiway centerline to fixed or movable object of $0.6 \times \text{wingspan} + 10$ ft which equals 138 ft while the existing separation is as shown in Figure H-8.		
Restrictions	Taxiway S use is restricted to B-727 aircraft. This will increase the existing separation of 220 ft to 273 ft ($220 + 214/2 - 108/2$). 273 ft of taxiway separation exceeds the standard requirements. Restrict operations on Taxiway S to B-727 Group III aircraft.		
Justification	Based on the modified equation found in AC 150/5300-13, Chapter 2, at the bottom of Table 2-3 ($0.6 \times \text{wingspan} + 10$ ft), taxiway OFA of 130 ft provided clearance of more than 10 ft from the airplane wingtip to the parked aircraft. Taxiway S restriction allowed for enough clearance between the two taxiways when the largest aircraft expected to travel on Taxiway JB and the largest aircraft allowed in Taxiway S traveled side-to-side.		

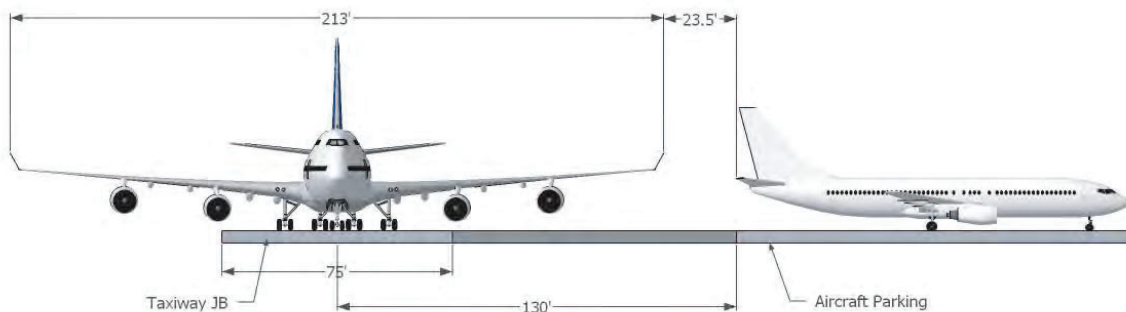

WR

Application of Methodology

Risk Plot	AA-26 (TLN/OBJ) AA-7 (TWY/TWY)	Wingtip Sep	130 ft (TLN/OBJ) 23.5 ft (TWY/TWY)
Severity	Major	Risk Level	1.0E-09 1.0E-09
Conclusion	Low Risk	Acceptable	

Case Study # 9 - Minneapolis- St. Paul International Airport (MSP)

MO Issue	Taxiway/ Taxiway	Approval Date	3/6/2006
Separations	OFA	Centerline	Wingtip
Standard		215 ft	
Existing		154 ft	35 ft
Airport Reference	C-IV		
Critical Aircraft	Aircraft 1	Aircraft 2	
Model	B757-300	B757-300	
ADG	IV	IV	
Wingspan	125 ft	125 ft	
Synopsis	<p>In order to accommodate push-backs from Concourse B and for the aircraft to remain in the non-movement area without blocking Taxiway , a relocation/realignment of Taxiway was required. The proposed MOS was to relocate a portion of Taxiway between P2 and P3, moving it closer to Taxiway P.</p> <p>In order to maintain an acceptable level of safety on the parallel taxiways, the use of the reduced separation segment of Taxiway P was restricted to aircraft with wingspan no larger than 124.8 ft (B-757 size aircraft), and the use of the reduced separation segment of Taxiway was limited to aircraft with wingspans no larger than 111.9 ft (A-320 size aircraft).</p>		
Restrictions	<p>Use of Taxiway P between P2 and P3 limited to aircraft with maximum wingspan of 124.8 ft.</p> <p>Use of Taxiway between P2 and P3 limited to aircraft with maximum wingspan of 111.9 ft.</p> <p>Operational restrictions on Taxiways P and to aircraft with wingspan no larger than 124.8 ft and 111.9 ft, respectively.</p> <p>Pavement marking changes to the 30R deicing pad renumbering circle 99 to circle 95.</p> <p>Adjustment to the deicing pad route to allow for a Mesaba staging area and facilitate the regional aircraft operations Concourses A and B.</p> <p>Reduce the painted Taxiway width from 75 ft to 50 ft on the affected segment of the taxiway to ensure object clearance.</p> <p>Change in the current Airport Layout Plan to reflect the changes to the taxiways and operational restrictions.</p> <p>Make regional airlines aware of jet blast issues posed by the proposed Mesaba staging area near the deicing pad.</p> <p>During special circumstances, when aircraft larger than 124.8 ft need to use Runway 12L/30R, parking on the east end of Taxiway P should only be granted if Taxiway is not in use.</p>		
Justification	<p>Limited space availability to relocate Taxiway P.</p> <p>The taxiway OFA provides an acceptable level of safety based on the modified equations provided in AC 150/5300-13 below Table 2-3 and Table 4-1.</p> <p>Wingtip clearance of aircraft on both taxiways is acceptable when the aircraft main gear wheels remain entirely within the boundaries of the taxiway.</p>		

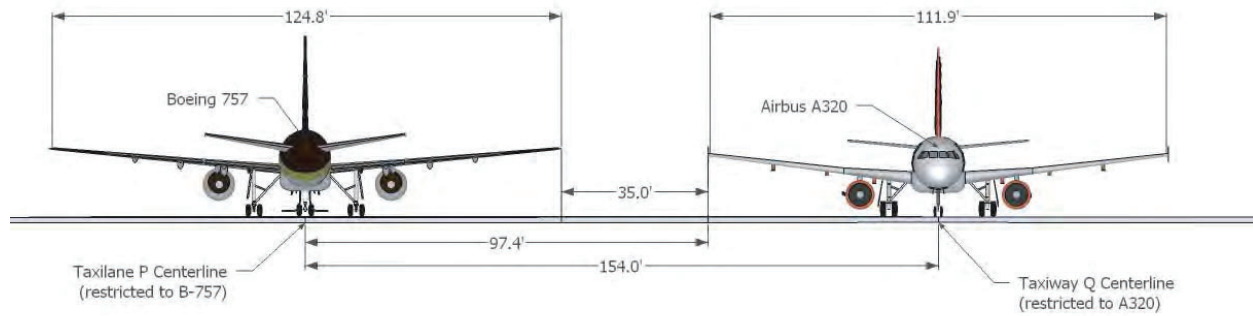

Application of Methodology

Risk Plot	AA-7	Wingtip Sep	35 ft
Severity	Major	Risk Level	1.0E-09
Conclusion	Low Risk	Acceptable	

Case Study # 10 - Chicago O'Hare International Airport (ORD)

MO Issue	Taxiway/Object	Approval Date	9/30/2005
Operations	OFA	Centerline	Wingtip
Standard	160 ft		
Existing	131 ft		
Airport Reference	D-V		
Critical Aircraft	Aircraft 1	Aircraft 2	
Model	B747-400	N/A	
ADG	V		
Wingspan	213		
Synopsis	The existing separation between Taxiway A and the terminal core service road that is located next to Concourses C, E, F, G, and H is 131 ft, while the required taxiway object OFA is 160 ft. At the time the taxiway and terminal were built, the 131-ft OFA complied with ADG V standards. However, these standards have been revised, and AC 150/5300-13, Chapter 2, Table 2-3, now mandates a larger OFA of 160 ft. An MOS was requested to keep the existing taxiway/object separation while subjecting the ADG V operations. Safety was maintained by placing certain operational restrictions on the use of Taxiway A.		
Restrictions	Use of Taxiway A by ADG V aircraft should be in accordance with the conditions for MOS approval.		
Justification	Existing taxiway to object separation was based on ADG V standards at the time of the taxiway and terminal development.		

<p>Conditions for Approval</p>	<p>Taxiway A should contain green colored bi-directional centerline lights.</p> <p>Taxiway A centerline lights must be operational during A330, A340, B747-400, MD11, and B777 aircraft operations.</p> <p>Maintain, monitor, and enforce the aircraft parking limit line among all tenants and ground personnel.</p>
--------------------------------	---

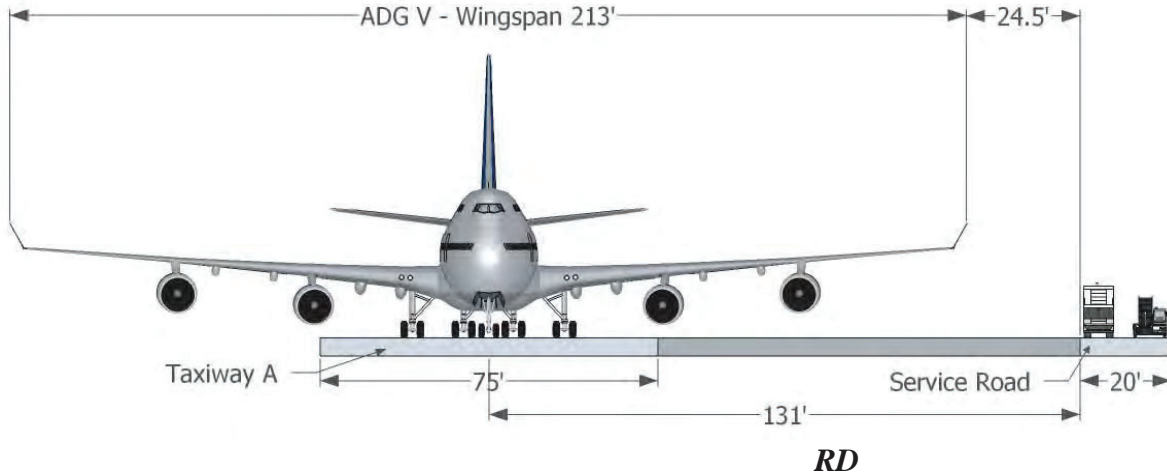

Application of Methodology

Risk Plot	AA-12	Centerline Sep	131 ft
Severity	Major	Risk Level	3.2E-10
Conclusion	Low Risk	Acceptable	

Case Study # 11 - Chicago O'Hare International Airport (ORD)

MO Issue	Taxiway/Taxiway	Approval Date	9/30/2005
Operations	OFA	Centerline	Wingtip
Standard		267 ft	
Existing		251 ft	
Airport Reference	D-V		
Critical Aircraft	Aircraft 1	Aircraft 2	
Model	B747-400		B747-400
ADG	V		V
Wingspan	196		196
Synopsis	<p>The existing separation between Taxiways A and B is 251 ft, while the required separation is 267 ft. At the time the taxiways were built, 251 ft complied with the FAA design criteria. However, the standards have been revised and now AC 150/5300-13, Chapter 2, Table 2-3 mandates a larger separation of 267 ft.</p> <p>Operations on Taxiways A and B at ORD are managed by FAA Air Traffic Order ORD 7110.65C with an adequate level of safety. Therefore, after</p>		

	evaluating other alternative solutions to the separation between Taxiways A and B, an MOS was requested to keep the existing separation while following the mentioned Air Traffic Order operation restrictions.
Restrictions	In accordance with FAA Air Traffic Order ORD 7110.65C, no simultaneous taxi operations on Taxiways A and B are allowed for B747-400, B777-300, and A340-600 aircraft, and no aircraft is allowed to stop on the Taxiway A or Taxiway B bridges.
Justification	Existing parallel taxiway centerline separation was consistent with the FAA design standards at the time of the taxiways construction. A separation of 251 ft is acceptable subject to the operation restrictions contained in FAA Air Traffic Order ORD 7110.65C.
Conditions for Approval	Taxiway A should contain green colored bi-directional centerline lights. Taxiway A centerline lights must be operational during A330, A340, B747-400, MD11, and all series of B777 aircraft operations. Maintain and observe the aircraft parking limit line. No simultaneous taxi operations on Taxiways A and B are allowed for B747-400, B777-300, and A340-600 aircraft. No aircraft is allowed to stop on the Taxiway A or Taxiway B bridges.

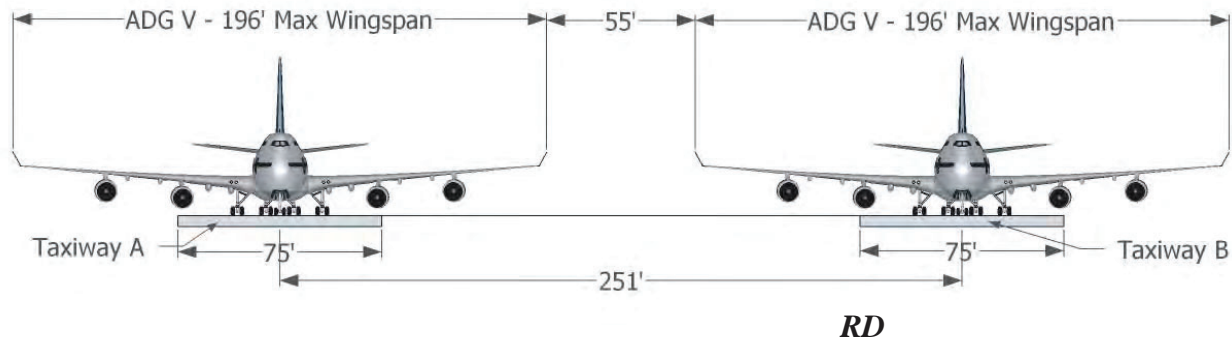

Application of Methodology

Risk Plot	AA-5	Centerline Sep	251 ft
Severity	Major	Risk Level	1.0E-09
Conclusion	Low Risk	Acceptable	

Case Study # 12 - Barnstable Municipal Airport (HYA)

MO Issue	Runway/Taxiway	Approval Date	8/17/1998
Separations	OFA	Centerline	Wingtip
Standard		400 ft	282 ft
Existing		300 ft	219 ft
Airport Reference	B-III		

critical Aircraft	Aircraft 1	Aircraft 2
Model	ATR-42	ATR-42
ADG	III	III
Wingspan	81	81
ynopsis	<p>The northern section of Taxiway A, a 20-year old taxiway, was scheduled by HYA for rehabilitation. The existing separation between Taxiway A and Runway 15/33 is 300 ft rather than the required 400 ft by AC 150/5300-13, Chapter 2, Table 2-2. The northern section of Taxiway A is 50 ft in width while the southern section of the taxiway has a width of 60 ft. The width of the taxiway is not an issue since the entire taxiway meets or exceeds the minimum required width of 50 ft.</p> <p>Three options were considered and an MOS request was selected. It was determined that enough clearance space would exist between the existing runway safety area (RSA) and the runway Obstacle Free one, which is offset from the centerline of Runway 15/33 by 250 ft and 200 ft, respectively. The clearing between the RSA and the tip of the wing of the critical aircraft in a 50-ft-wide taxiway was calculated to be 9.7 ft.</p>	
Restrictions	Maintain ATR-42 characteristics as most demanding aircraft.	
ustification	<p>Cost feasibility.</p> <p>Negative impacts to the airport apron/terminal/parking capacity.</p> <p>Acquisition and cleaning of adjacent contaminated land needed for relocation.</p> <p>Airport design aircraft is less demanding than Group C representative aircraft.</p> <p>The RSA and runway OFA are satisfied utilizing the most demanding aircraft (ATR-42).</p>	
onditions for Approval	Maintaining ATR-42 or less demanding design aircraft	

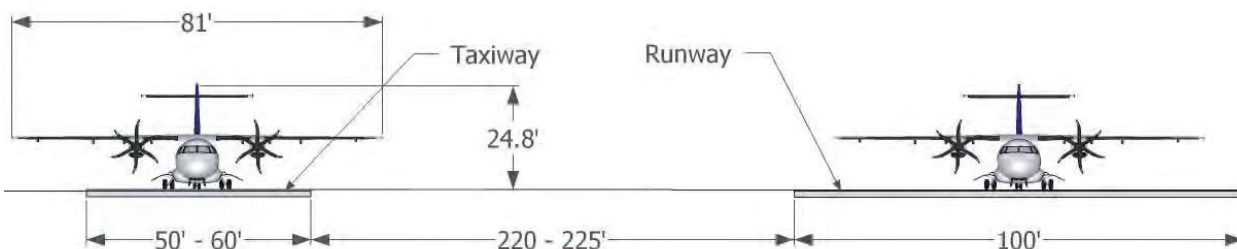

Application of Methodology

Risk Plot	AA-33 and AA-43	Centerline Sep	
Severity	Catastrophic	Risk Level Airborne	1.1E-09
		Risk Level Ground	1.0E-07
Annual Vol. Operations	118,000	Expected Years	> 100 years
Conclusion	Medium Risk	Mitigation Recommended	

Case Study # 13 - Laconia Municipal Airport (LCI)

MO Issue	Runway/Taxiway	Approval Date	4/24/1974
Separations	Runway OFA	Taxiway OFA	Centerline
Standard	500 ft	166 ft	400 ft
Existing	300 ft	110 ft	210 ft
Airport Reference	C-III		
Critical Aircraft	Aircraft 1	Aircraft 2	
Model	B727-200		B727-200
ADG	III		III
Wingspan	108		108
Synopsis	<p>A taxiway measuring 2,700 ft long and 50 ft wide ran parallel to Runway 7/25 (currently labeled as Runway 8/26). The separation between the runway and the existing taxiway was 210 ft, rather than the required 400 ft by AC 150/5300-13, Chapter 2, Table 2-2.</p> <p>Due to economic constraints, the feasible solution to the separation non-compliance was to request an MOS. After a detailed analysis of several representative aircraft, it was determined that the existing separation provided adequate clearance for two critical aircraft (B727-200) traveling side by side in the taxiway and runway, respectively. Maintaining the existing separation of 210 ft as shown in Figure H-13, the clearing between the wing tips of the two aircraft was calculated to be 123 ft.</p> <p>Although the B-727 was listed as the critical aircraft, that aircraft was not operating at the airport at that time. MOS is predicated upon commuter service type aircraft - Piper Apache or a De Havilland Twin Otter. In 2010, LCI does not have a Part 139 certificate, and it is doubtful that in the future it would have any operations by large aircraft such as B-727.</p>		
Restrictions	<p>Airport is certified by the Civil Aeronautics Board (CAB) for seasonal service, which is provided by Delta using a Piper Apache as substitute commuter.</p> <p>Basic transportation criteria 150/5300-6 is considered in lieu of air carrier taxiway standards.</p>		
Justification	<p>Cost feasibility - taxiway already existed at time the MOS was constructed.</p> <p>Clearance evaluation of two of the most demanding aircraft (B-727-200) passing side-by-side in the runway and taxiway proved satisfactory.</p>		
Conditions for Approval	<p>Continued commuter substitute service.</p> <p>Construct taxiway safety area conforming to general aviation transport criteria.</p>		

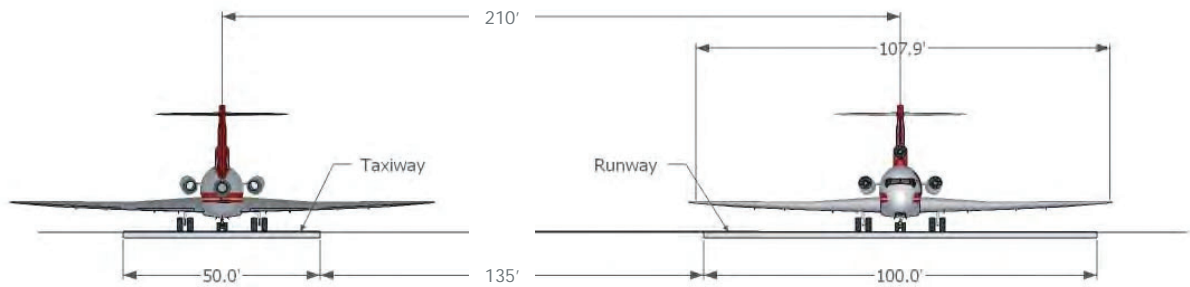

Application of Methodology

Risk Plot	AA-33 and AA-43	Centerline Sep	210 ft
Severity	Catastrophic	Risk Level Airborne	5.0E-09
		Risk Level Ground	2.0E-07
Annual Vol. Operations	37,600	Expected Years	> 100 years
Conclusion	Medium Risk	Mitigation Recommended	

Case Study # 14 - Seattle-Tacoma International Airport (SEA)

MO Issue	Runway/Taxiway	Approval Date	6/12/2009
Operations	OFA	Centerline	Wingtip
Standard		500 ft and 550 ft	
Existing		400 ft	
Airport Reference	D-VI		
Critical Aircraft	Aircraft 1	Aircraft 2	
Model	B747-800	B747-800	
ADG	VI	VI	
Wingspan	224	224	
ynopsis	<p>Based on AC 150/5300-13, Chapter 2, Table 2-2, the required runway to taxiway separation at SEA is 400 ft for a CAT I approach, 500 ft for CAT II/III approach with a visibility no lower than statute mile, and 550 ft for CAT II/III approach with a visibility less than statute mile. The existing northernmost section of Taxiway B is located 400 ft east of the approach end of Runway 16L and thus complies with the requirement for CAT I approaches, but provides less than the required separation for CAT II/III approaches.</p> <p>With the introduction of Boeing aircraft model 747-800, the airport's ADG changed from D-V to D-VI, and the required runway to taxiway separation increased from 400 ft to 500 ft-550 ft depending on visibility conditions. The northern 3,000 ft of Taxiway B had an existing tail height restriction of 48 ft for aircraft taxiing on it during CAT II/III approaches. This restriction would also apply to the B747-800. An MOS was requested to allow the B-747-800 to operate on the northern 3,000 ft of Taxiways A and B as had previously been approved for the B-747-400.</p>		

Restrictions	<p>Aircraft with a maximum tail height of 48 ft are allowed on the northern 3,000 ft portion of Taxiway B during CAT II and CAT III ILS operations on Runway 16L.</p> <p>Aircraft with tail heights exceeding 48 ft are restricted from operating on Taxiway A during CAT II and CAT III low visibility conditions.</p>
Justification	<p>Current runway to taxiway separation distance complies with prior airport ADG corresponding to D-V (Boeing B747-400).</p> <p>The southern portion of Taxiway B (south of Taxiway L) provides a 600-ft separation between the runway and taxiway centerlines, thus providing an adequate clearance for CAT II and CAT III operations under low visibilities.</p>
Conditions for Approval	<p>B-747-800 aircraft are not allowed to taxi on the northern-most 3,000 ft section of Taxiway B during CAT II/III approaches to Runway 16L since the aircraft's tail height exceeds the 48 ft maximum that had previously been established for operations on that taxiway under those visibility conditions.</p> <p>Taxiway A must be utilized for B-747-800 taxiing when restricted use of Taxiway B is in effect.</p>

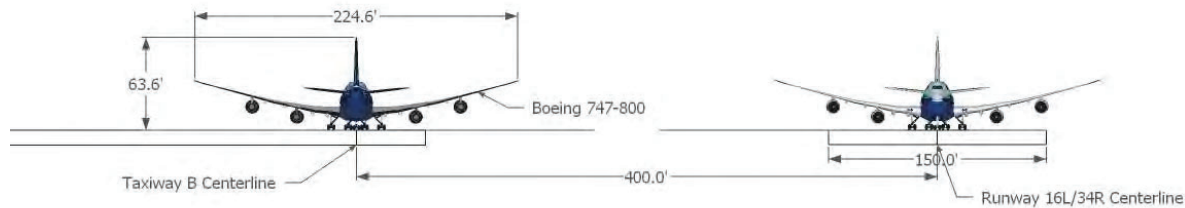

Application of Methodology

Risk Plot	AA-40 and AA-46	Centerline Sep	
Severity	Catastrophic	Risk Level Airborne	1.5E-06
		Risk Level Ground	1.2E-07
Annual Vol. Operations		Expected Years	> 100 years
Conclusion	High Risk		

Case Study # 15 - Seattle-Tacoma International Airport (SEA)

MO Issue	Taxiway/Taxilane	Approval Date	6/2/2009
Operations	OFA	Centerline	Wingtip
Standard		324 ft	62 ft
Existing		219 ft	44.3 ft
Airport Reference	D-VI		

Critical Aircraft	Aircraft 1	Aircraft 2
Model	B747-800	B757-200
ADG	VI	IV
Wingspan	224	125
Synopsis	<p>Taxiway B parallels Taxilane W in the passenger terminal area. Taxiway B was designed to comply with ADG V requirements and provide adequate separation for aircraft up to 125 ft wingspan (B757-200). The existing separation between Taxiway B and Taxilane W is 219 ft. Since year 2009, Boeing B747-800 aircraft started operating at SEA, increasing the Airport Reference Code to D-VI and requiring 62 ft wingtip clearance (AC 150/5300-13, Chapter 4, Table 4-3). The only feasible alternative was to limit operations on Taxilane W. An MOS was filed in order to keep the existing spacing configuration and to allow B747-800 aircraft to operate on Taxiway B and aircraft with wingspans up to 125 ft to operate on Taxilane W without restrictions.</p>	
Restrictions	<p>Aircraft on Taxilane W should operate at 20 mph or less.</p> <p>Limit operations on Taxiway B to aircraft no larger than 224.4 ft wingspan (Boeing B747-800).</p> <p>Limit operations on Taxilane W to aircraft no larger than 125 ft wingspan (Boeing B757-200).</p> <p>Restrict the use of Taxiway B during pushback of aircraft types B757, ADG IV, and ADG V.</p>	
Justification	<p>Cost limitations to relocate Taxiway B to the west of the airport.</p> <p>Limited space and negative impact on the aircraft terminal parking to relocate Taxilane W to the east of the airport.</p> <p>Negative impact on airfield efficiency by restricting the use of Taxilane W to aircraft with wingspans that would provide the required 62 ft wingtip clearance.</p> <p>Using the modified equation on AC 150/5300-13, Chapter 4, at the bottom of Table 4-3, $(0.2 \times \text{wingspan} + 10 \text{ ft})$ the average wingtip clearance for an ADG IV taxilane and an ADG VI taxiway required a minimum wingtip separation of 42.3 ft. This distance is less than the available wingtip separation of 44.3 ft between the typical aircraft using Taxiway B (Boeing B747-800) and the typical aircraft using Taxilane W (Boeing B757-200).</p> <p>Statistical studies indicate that B747s are not likely to deviate from centerlines of straight taxiways such as Taxiway B.</p> <p>B747 operations represent less than 1% of the total operations at the airport and the number of operations for B747-800 is a very small portion of the total B747 operations.</p> <p>The probability of having a B747-800 on Taxiway B traveling side-to-side with a B-757 on Taxilane W is very small.</p>	

<p>Conditions for Approval</p>	<p>Restrict operations on Taxiway W to aircraft with a maximum wingspan of 125 ft.</p> <p>Aircraft on Taxiway W should operate at 20 mph or less.</p> <p>Maintain the existing taxiway centerline lighting and taxiway centerline reflectors to provide guidance to the pilots during taxi.</p>
--------------------------------	---

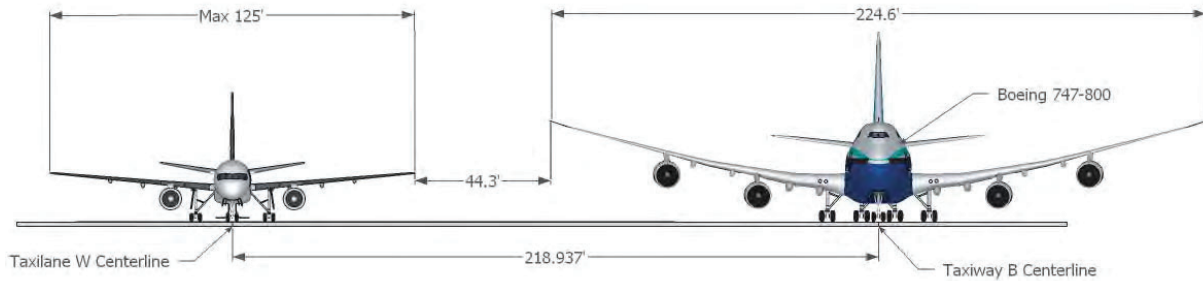

Application of Methodology

Risk Plot	AA-7	Wingtip Sep	44 ft
Severity	Major	Risk Level	1.0E-09
Conclusion	Low Risk	Acceptable	

Case Study # 16 - Aspen-Pitkin County Airport (ASE)

MO Issue	Runway/Taxiway	Approval Date	3/5/1999
Operations	Runway OFA	Taxiway OFA	Centerline
Standard		186 ft	400 ft
Existing		169 ft	320 ft
Airport Reference	D-III		
Critical Aircraft	Aircraft 1	Aircraft 2	
Model	Grumman Gulfstream IV		Grumman Gulfstream IV
ADG	III		III
Wingspan	78		78
Synopsis	<p>Based on AC 150/5300-13, Chapter 2, Table 2-2, the required runway to taxiway separation at ASE, classified as an ADG D-III airport, is 400 ft. A relocation of the existing taxiway was proposed to increase the runway/taxiway separation from 221.5 ft to 320 ft. Still, the new separation of 320 ft was less than the required 400 ft and thus an MOS was requested.</p> <p>Locating the taxiway at the required 400 ft was not feasible due to the space limitations that Highway 82, the airport frontage road, auto parking lots, and six other buildings posed on the area of interest. The alternative taxiway relocation only impacted the long-term and employee parking and the ARFF building.</p>		

	The proposed taxiway alignment was such that the western boundary of the taxiway OFA coincided with the eastern boundary of runway OFA. The width of the OFA on the runway side is 93 ft, which is half of the standard width of taxiway OFA s of 186 ft. However, the location of the relocated taxiway provides an OFA width of 76 ft (93 ft required by standard) between the taxiway and the apron. The apron cannot be relocated due to space constraints identified in preceding paragraph.
Restrictions	Location of airplanes on parking apron should be no closer than 493 ft from the runway centerline. Operations restricted to aircraft with wingspan no larger than 95 ft.
Justification	Lack of space to relocate the existing highway, roads, auto parking, and buildings. Full width taxiway OFA is provided on runway side of the taxiway. Limiting aircraft wing spans to 95 ft provides an adequate taxiway OFA on the apron side in accordance with AC 150/5300-13, Chapter 2, Table 2-3, using the modified formula at the bottom of the table for calculating OF widths for specific aircraft ($0.7 \times \text{wingspan} + 10 \text{ ft}$).
Conditions for Approval	Use of the airport restricted to aircraft with wingspan no larger than 95 ft.

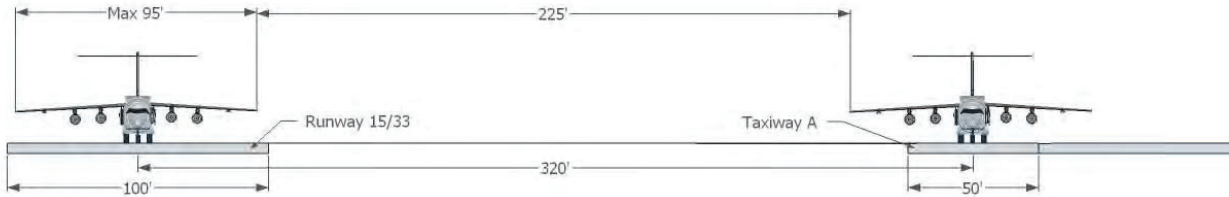

Application of Methodology

Risk Plot	AA-33, AA-34, and AA-43	Centerline Sep	320 ft
Severity	Catastrophic	Risk Level Airborne	Cat I – 8.5E-10 Cat II – 9.0E-09
		Risk Level Ground	9.0E-08
Annual Vol. Operations	45,000	Expected Years	> 100 years
Conclusion	Medium Risk	Mitigation Recommended	

Case Study # 17 - Nantucket Memorial Airport (ACK)

MO Issue	Taxiway/Taxiway	Approval Date	5/6/1986
Separations	OFA	Centerline	Wingtip
Standard		152 ft	
Existing		125 ft	44 ft
Airport Reference	C-III		
Critical Aircraft	Aircraft 1	Aircraft 2	
Model			
ADG	III		
Wingspan	107 ft	55 ft	
Synopsis	<p>An extension of Taxiway E from Taxiway C (now labeled D) to the approach end of Runway 24 would have caused the existing Taxiway F (extending from the terminal apron to the approach end of Runway 24) to be abandoned because the separation between the new Taxiway E and the existing Taxiway F did not meet standards. Abandoning Taxiway F would have caused a number of problems such as disconnection between the T-hangars and the run-up area; conflict among the north ramp, the main terminal ramp, and the southwest general aviation ramp traffic; and back taxi to achieve full length departure on Runway 15.</p> <p>The Taxiway E extension was located in accordance with standards so that the distance between Taxiway E's centerline and Runway 24's centerline was 400 ft. This resulted in the separation distance between the parallel Taxiways (E and F) being 125 ft versus the required separation of 153 ft. To avoid abandoning Taxiway F, an MOS to the standard separation between Taxiway E and F was requested.</p> <p>The required parallel taxiway separation for the critical ADG III per AC 150/5300-13, Chapter 2, Table 2-3 was 152 ft. While airport use by these types of aircraft was infrequent at AC, simultaneous operation of aircraft on the parallel Taxiways E and F was still a possibility. Therefore, to maintain an acceptable level of safety, the approval of the MOS was conditioned upon several operational restrictions.</p>		
Restrictions	<p>Use restricted by direction of air traffic control.</p> <p>Use restricted to daylight only.</p> <p>Use of Taxiway F restricted to small airplanes (max gross weight of 12,500 lb).</p> <p>Guidance signs unlighted.</p> <p>Existing lighting circuit discontinued.</p> <p>Taxiway safety area grading requirements as per AC 150/5300-12.</p>		

Justification	<p>Comply with Runway 6/24 to Taxiway E standard separation.</p> <p>Maintain flexibility of operations and flow by air traffic control during peak traffic conditions.</p> <p>Satisfactory wingtip clearance when no simultaneous operation of ADG III aircraft occurs on the parallel taxiways.</p>
Conditions for Approval	<p>Restrict operations on this portion of the taxiway to daytime.</p> <p>Restrict use of this portion of the taxiway to aircraft of 12,500 lb or less.</p> <p>Maintain this portion of the taxiway unlighted.</p>

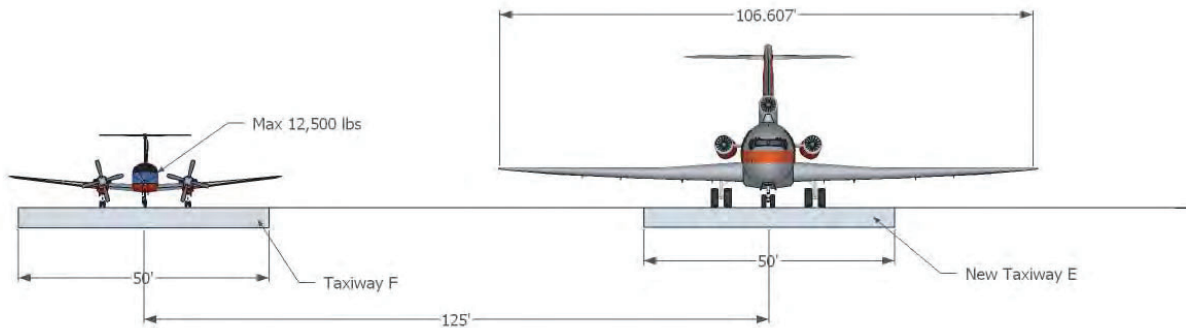

Application of Methodology

Risk Plot	AA-7	Wingtip Sep	44 ft
Severity	Major	Risk Level	1.0E-09
Conclusion	Low Risk	Acceptable	

Case Study # 18 - New Castle Airport (ILG)

MO Issue	Taxiway/Object	Approval Date	6/29/2000
Operations	OFA	Centerline	Wingtip
Standard	259 ft	129.5 ft	
Existing	206 ft	103 ft	
Airport Reference	D-V		
Critical Aircraft	Aircraft 1	Aircraft 2	
Model	AC-130 Spectre	N/A	
ADG	IV		
Wingspan	132.5		

<p>ynopsis</p>	<p>The existing separation between Taxiway A and the movement/non-movement area near the aviation hangar located between Taxiways A3 and A4 is 103 ft. The required taxiway OFA width per AC 150/5300-13, Chapter 4, Table 4-1 is 259 ft or 129.5 ft separation between the taxiway centerline and the object.</p> <p>The location between Taxiway A3 and A4 on Taxiway A is designated as a fuel truck parking area. Complying with the required OFA standard would have displaced the parking space and placed the fuel truck too close to the aviation hangar, in violation of fire code. Since there were no other available parking areas for the fuel trucks, a MOS was requested to reduce the separation between the centerline of Taxiway A and the object (i.e., fuel trucks) and thus allow enough clearance between the fuel trucks and the hangar. Reduced separation is based on C-130, the largest aircraft using the airport.</p>
<p>Restrictions</p>	<p>Maintain Hercules C-130 characteristics as most demanding aircraft.</p>
<p>ustification</p>	<p>No other parking area available for aircraft fuel trucks.</p> <p>The required separation would have located the parked fuel trucks too close to the aviation hangar, in violation of fire code.</p> <p>Using the formula $(1.4 \times \text{wingspan} + 20)$ found in AC 150/5300-13, Chapter 4, at the bottom of Table 4-1, the required separation between the taxiway centerline and the object resulted in 103 ft.</p> <p>Calculated clearance of 35.5 ft beyond the critical aircraft (i.e., C130) wingtip and 17.3 ft beyond the safety area edge.</p>
<p>onditions for Approval</p>	<p>Movement/non-movement line painted at 103 ft from centerline of Taxiway A to delineate the parking limit for the fuel trucks.</p>

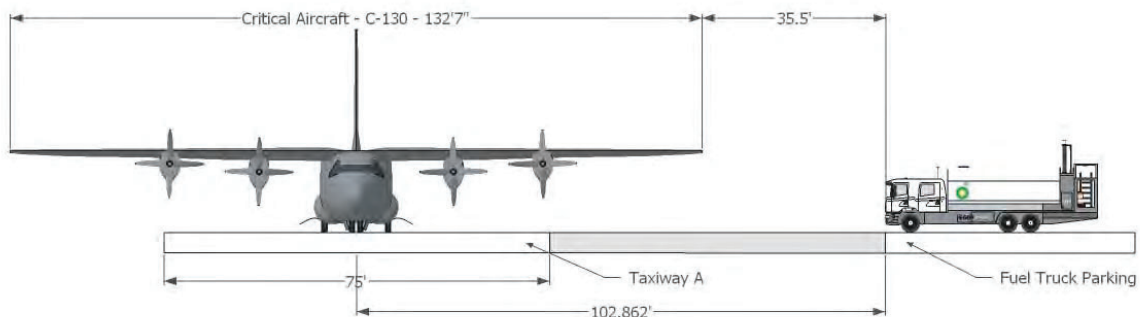

Application of Methodology

<p>Risk Plot</p>	<p>AA-11</p>	<p>Centerline Sep</p>	<p>103 ft</p>
<p>Severity</p>	<p>Major</p>	<p>Risk Level</p>	<p>2.8E-08</p>
<p>Conclusion</p>	<p>Low Risk</p>	<p>Acceptable</p>	

Case Study # 19 - Leesburg Municipal Airport (JYO)

MO Issue	Runway/Object	Approval Date	3/26/1997
Separations	OFA	Centerline	Wingtip
Standard	800 ft	300 ft	
Existing	750 ft	262.5 ft	
Airport Reference Code	C-II		
Critical Aircraft	Aircraft 1	Object	
Model	Grumman Gulfstream III		
ADG	II		
Wingspan	79		
Synopsis	<p>Based on AC 150/5300-13, Chapter 2, Table 2-2, the required runway to taxiway separation at JYO was 300 ft for a C-II aircraft. Locating the parallel taxiway at the required distance would have required one T-hangar unit and two hexagon hangar units to be relocated or reconstructed.</p> <p>In addition to the relocation/reconstruction of the hangars, other existing infrastructure elements such as the taxiway lighting system, the drainage system, a storm water detention facility, and 60,000 square ft of apron would have been impacted. Due to the economic and airport space limitations that redesigning, relocating, and/or reconstructing the existing infrastructure elements would entail, an MOS was requested. Based on AC 150/5300-13, paragraph 209 and Appendix 11, the minimum calculated runway to taxiway separation for ADG II was 239.5 ft and thus the proposed taxiway relocation at 262.5 ft exceeded the minimum requirement.</p> <p>With respect to the runway OFA, AC 150/5300-13, Chapter 3, Table 3-3 requires a width of 800 ft versus the 750 ft existing separation available. However, the hangar structures were outside of the taxiway OFA, the runway safety area (RSA), and the runway object free zone (OFZ). Besides, following the recommendations of a previous study, the hangar structures were marked with obstruction lights to prevent classifying them as hazards. JYO has only right angle taxiway exits from its runway, and there are not any plans to construct acute angle exits. The 400-ft half-width standard is based on a runway with acute angle exits.</p>		
Restrictions	<p>Limit runway and taxiway use to Group II aircraft.</p> <p>Limit Group II aircraft to right-angled exits to assure required turning radii and fillets.</p> <p>Mark the T-hangar and hexagon hangar units with obstruction lights.</p>		
Justification	<p>Relocation/reconstruction of one T-hangar unit, two hexagon hangars, the entire taxiway lighting system, and the existing drainage system.</p> <p>Loss of approximately 60,000 of usable apron.</p> <p>Redesign and reconstruction of a storm water detention facility.</p>		

	<p>Economic feasibility.</p> <p>Capacity and space limitations.</p> <p>Adequate runway to taxiway clearance for Group II aircraft based on AC 150/5300-13 Appendix 11 calculations.</p> <p>Adequate turning radii and fillets for right-angled exits.</p> <p>Mitigation of penetration hazards by marking the hangars with obstruction lights.</p>
Conditions for Approval	Unconditional approval granted with the specified operational restrictions.

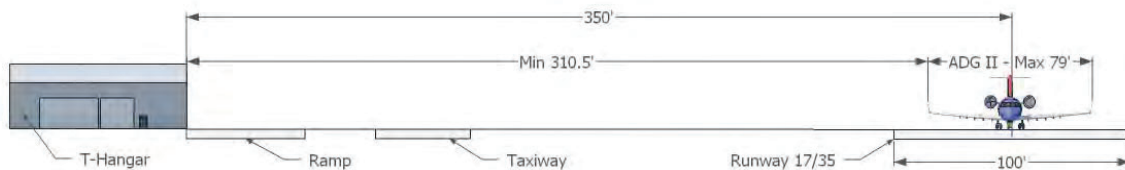

Application of Methodology

Risk Plot	TWY: AA-31 and AA-42	Centerline Sep	TWY: 262.5 ft OBJ: 375 ft
Severity	Catastrophic	Risk Level Airborne	TWY: 1.2E-10 OBJ: 3.3E-11
		Risk Level Ground	TWY: 1.2E-07 OBJ: 6.0E-08
Annual Vol. Operations	103,700	Expected Years	> 100 years
Conclusion	Medium Risk	Mitigation Recommended	

Case Study # 20 - Taunton Municipal Airport (TAN)

MO Issue	Runway/Taxiway	Approval Date	6/26/2002 (subm.)
Comparisons	Runway OFA	Taxiway OFA	Centerline
Standard			240 ft
Existing			197 ft
Airport Reference	B-II		
Critical Aircraft	Aircraft 1	Aircraft 2	
Model	Beeching Air C90	Beeching Air C90	
ADG	II	II	
Wingspan	50	50	

Synopsis	The parallel taxiway to Runway 12/30 was reconstructed in 1960 and its separation from the runway spans 197 ft. In order to comply with the 240 ft separation requirement per AC 150/5300-13, Chapter 2, Table 2-1, a relocation of the taxiway was considered as the primary option. This, however, was not feasible due to the existence of a stream parallel to a portion of the taxiway, and the negative impact on aircraft parking and existing wetlands that a relocation of the parallel taxiway would cause. Therefore, an MOS was requested to keep the existing separation given the fact that the RSA and OF distances provided enough clearance for the critical aircraft operating at the airport (i.e., Beach King Air C90).
Restrictions	Maintain Beach King Air C90 characteristics as most demanding aircraft.
Justification	<p>The stream running parallel to a portion of the existing taxiway posed space constraints that made the relocation of the parallel taxiway unfeasible.</p> <p>Negative environmental impacts on the existing wetlands caused by relocating the stream running parallel to a portion of the existing taxiway.</p> <p>Negative impact on aircraft parking caused by relocating the parallel taxiway.</p> <p>The runway safety area and obstacle free zone are satisfied by the critical aircraft, namely a Beach King Air C90.</p>
Conditions for Approval	Restudy of the proposed MOS if a significant change in aircraft size or volume operations occur at TAN.



Application of Methodology

Risk Plot	AA-31 and AA-47	Centerline Sep	197 ft
Severity	Catastrophic	Risk Level Airborne	3.0E-10
		Risk Level Ground	8.0E-08
Annual Vol. Operations	31,400	Expected Years	> 100 years
Conclusion	Medium Risk	Mitigation Recommended	

Abbreviations and acronyms used without definitions in TRB publications:

AAAE	American Association of Airport Executives
AASHO	American Association of State Highway Officials
AASHTO	American Association of State Highway and Transportation Officials
ACI-NA	Airports Council International-North America
ACRP	Airport Cooperative Research Program
ADA	Americans with Disabilities Act
APTA	American Public Transportation Association
ASCE	American Society of Civil Engineers
ASME	American Society of Mechanical Engineers
ASTM	American Society for Testing and Materials
ATA	Air Transport Association
ATA	American Trucking Associations
CTAA	Community Transportation Association of America
CTBSSP	Commercial Truck and Bus Safety Synthesis Program
DHS	Department of Homeland Security
DOE	Department of Energy
EPA	Environmental Protection Agency
FAA	Federal Aviation Administration
FHWA	Federal Highway Administration
FMCSA	Federal Motor Carrier Safety Administration
FRA	Federal Railroad Administration
FTA	Federal Transit Administration
HMCRP	Hazardous Materials Cooperative Research Program
IEEE	Institute of Electrical and Electronics Engineers
ISTEA	Intermodal Surface Transportation Efficiency Act of 1991
ITE	Institute of Transportation Engineers
NASA	National Aeronautics and Space Administration
NASAO	National Association of State Aviation Officials
NCFRP	National Cooperative Freight Research Program
NCHRP	National Cooperative Highway Research Program
NHTSA	National Highway Traffic Safety Administration
NTSB	National Transportation Safety Board
PHMSA	Pipeline and Hazardous Materials Safety Administration
RITA	Research and Innovative Technology Administration
SAE	Society of Automotive Engineers
SAFETEA-LU	Safe, Accountable, Flexible, Efficient Transportation Equity Act: A Legacy for Users (2005)
TCRP	Transit Cooperative Research Program
TEA-21	Transportation Equity Act for the 21st Century (1998)
TRB	Transportation Research Board
TSA	Transportation Security Administration
U.S.DOT	United States Department of Transportation